

# R&S® HMO1002 Series R&S® HMO1202 Series Digital Oscilloscope User Manual

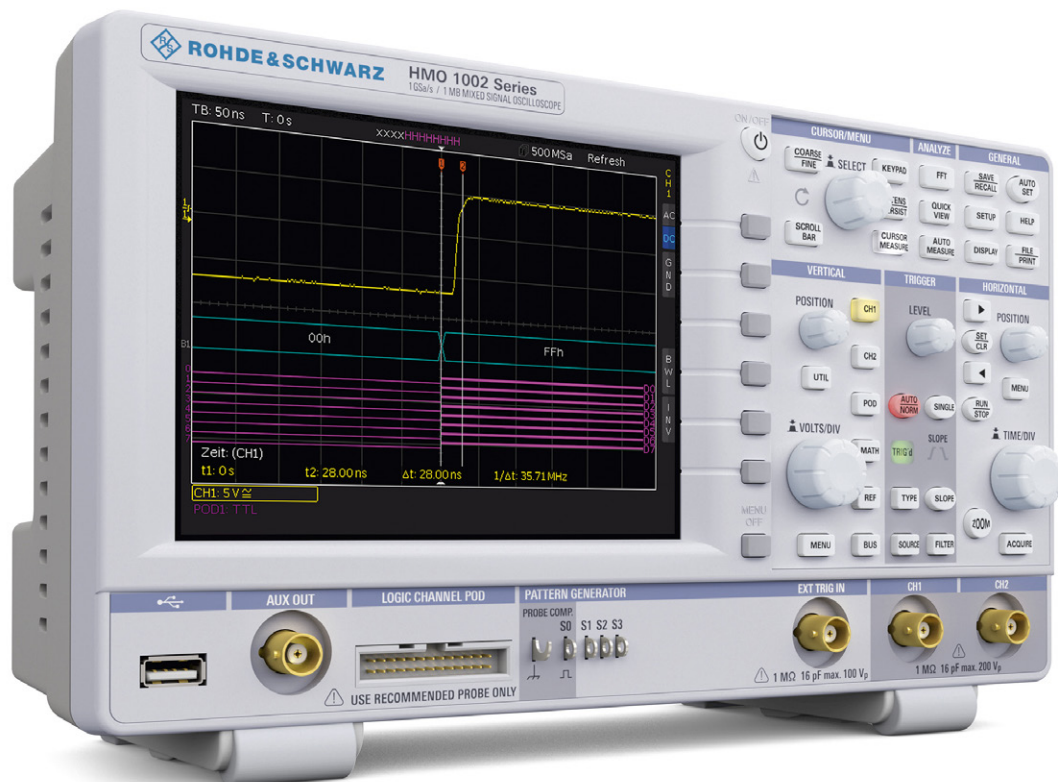

5800530103



## DECLARATION OF CONFORMITY

Manufacturer:

ROHDE & SCHWARZ GmbH & Co. KG · Mühldorfstr. 15 · D-81671 Munich

The ROHDE & SCHWARZ GmbH & Co. KG herewith declares conformity of the product:

**Product name:** Digital Oscilloscope  
**Type:** R&S®HMO1002 Series  
 R&S®HMO1202 Series  
**with:**  
**Options:**

complies with the provisions of the Directive of the Council of the European Union on the approximation of the laws of the Member States

- relating to electrical equipment for use within defined voltage limits (2006/95/EC) [LVD]
- relating to electromagnetic compatibility (2004/108/EC) [EMCD]
- relating to restriction of the use of hazardous substances in electrical and electronic equipment (2011/65/EC) [RoHS].

Conformity with LVD and EMCD is proven by compliance with the following standards:

- EN 61010-1: 2011
- EN 61326-1: 2013
- EN 61326-2-1: 2013
- EN 55011: 2009 + A1:2010
- EN 61000-3-2:2014
- EN 61000-3-3:2013

For the assessment of electromagnetic compatibility, the limits of radio interference for Class B equipment as well as the immunity to interference for operation in industry have been used as a basis.

**Date:** 07.05.2015

Signature:



### General Information Regarding the CE Marking

ROHDE & SCHWARZ measuring instruments comply with regulations of the EMC Directive. ROHDE & SCHWARZ is basing the conformity assessment on prevailing generic and product standards. In cases with potentially different thresholds, ROHDE & SCHWARZ instruments apply more rigorous test conditions. Thresholds for business and commercial sectors as well as small business are applicable for interference emission (class 1B). As to the interference immunity, the standard thresholds for the industrial sector apply. Measurement and data lines connected to the measuring instrument significantly affect compliance with specified thresholds. Depending on the respective application, utilized lines may differ. In regards to interference emission and immunity during measurements, it is critical that the following terms and conditions are observed:

#### 1. Data Cables

It is imperative to only use properly shielded cables when connecting measuring instruments and interfaces to external devices (printers, computers, etc.). Unless the manual prescribes an even shorter maximum cable length, data cables (input/output, signal/control) may not exceed a length of 3m and may not be used outside of buildings. If the instrument interface includes multiple ports for interface cables, only one cable at a time may be connected. Generally, interconnections require double-shielded connecting cables. The double-shielded cable HZ72 (available at ROHDE & SCHWARZ) is well suitable as IEEE bus cable.

#### 2. Signal Cables

In general, measuring cables for the transmission of signals between measuring point and measuring instrument should be kept as short as possible. Unless an even shorter maximum cable length is prescribed, signal cables (input/output, signal/control) may not exceed a length of 1m and may not be used outside of buildings. All signal cables must be shielded (coaxial cable RG58/U). It is important to ensure proper ground connection. Signal generators require the use of double-shielded coaxial cables (RG223/U, RG214/U).

#### 3. Impact on Measuring Instruments

If strong high-frequency electric and magnetic fields are present, it may occur despite diligent measurement setup that unwanted signal units are injected into the measuring instrument via connected measuring cables. This will not damage the ROHDE & SCHWARZ measuring instrument or put it out of operation. In some cases, these circumstances may cause the measuring value to slightly exceed specifications.

#### 4. RF immunity of oscilloscopes.

##### 4.1 Electromagnetic RF field

The influence of electric and magnetic RF fields may become visible (e.g. RF superimposed), if the field intensity is high. In most cases the coupling into the oscilloscope takes place via the device under test, mains/line supply, test leads, control cables and/or radiation. The device under test as well as the oscilloscope may be effected by such fields. Although the interior of the oscilloscope is screened by the cabinet, direct radiation can occur via the CRT gap. As the bandwidth of each amplifier stage is higher than the total -3 dB bandwidth of the oscilloscope, the influence of RF fields of even higher frequencies may be noticeable.

##### 4.2 Electrical fast transients / electrostatic discharge

Electrical fast transient signals (burst) may be coupled into the oscilloscope directly via the mains/line supply, or indirectly via test leads and/or control cables. Due to the high trigger and input sensitivity of the oscilloscopes, such normally high signals may effect the trigger unit and/or may become visible on the TFT, which is unavoidable. These effects can also be caused by direct or indirect electrostatic discharge.

# Content

<b>1</b>	<b>Important Notes</b>	<b>4</b>	<b>7</b>	<b>Signal Display</b>	<b>26</b>
1.1	Symbols	4	7.1	Display Settings	26
1.2	Unpacking	4	7.2	Usage of the Virtual Screen	26
1.3	Setting up the instrument	4	7.3	Signal Intensity Display and Persistence Function	26
1.4	Safety	4	7.4	XY display	27
1.5	Intended Operation	4	<b>8</b>	<b>Measurements</b>	<b>28</b>
1.6	Ambient conditions	5	8.1	Cursor Measurements	28
1.7	Warranty and repair	5	8.2	Automatic Measurements	29
1.8	Maintenance	5	<b>9</b>	<b>Analysis</b>	<b>32</b>
1.9	Measuring Category	5	9.1	Mathematical Functions	32
1.10	Mains voltage	6	9.2	Frequency Analysis (FFT)	34
1.11	Batteries and rechargeable batteries / cells	6	9.3	Quick View	35
1.12	Product Disposal	6	9.4	PASS/FAIL Test based on Masks	36
<b>2</b>	<b>Introduction</b>	<b>8</b>	9.5	Component Test	37
2.1	Front view	8	9.6	Digital Voltmeter	38
2.2	Control panel	8	<b>10</b>	<b>Signal Generation</b>	<b>39</b>
2.3	Screen	9	10.1	Function Generator	39
2.4	General Operating Concept	9	10.2	Pattern Generator	39
2.5	Basic Settings and Integrated Help	10	<b>11</b>	<b>Documentation, Storage and Recall</b>	<b>41</b>
2.6	Instrument Firmware Update	10	11.1	Device Settings	41
2.7	Options / Voucher	10	11.2	References	41
2.8	Self Alignment	11	11.3	Traces	42
2.9	Education Mode	12	11.4	Screenshots	43
2.10	Back Panel of the Instrument	12	<b>12</b>	<b>Mixed-Signal Operation</b>	<b>44</b>
<b>3</b>	<b>Quick Start Guide</b>	<b>13</b>	12.1	Logic Trigger for Digital Input	44
3.1	Setting up and turning the instrument on	13	12.2	Display Functions for the Logic Channels	44
3.2	Connection of a probe and signal capture	13	11.5	FILE/PRINT Key Definition	44
3.3	Display of signal details	13	12.3	Display of Logic Channels as BUS	45
3.4	Cursor Measurements	14	12.4	Cursor Measurements for Logic Channels	45
3.5	Automatic Measurements	14	12.5	Automatic Measurements for Logic Channels	46
3.6	Mathematical functions	15	<b>13</b>	<b>Serial Bus Analysis</b>	<b>46</b>
3.7	Storing data	15	13.1	Software options (license key)	46
<b>4</b>	<b>Vertical System</b>	<b>16</b>	13.2	Serial Bus Configuration	46
4.1	Coupling	16	13.3	Parallel / Parallel Clocked BUS	48
4.2	Sensitivity, Y Positioning and Offset	16	13.4	I <sup>2</sup> C BUS	48
4.3	Bandwidth Limit and Signal Inversion	16	13.5	SPI / SSPI BUS	50
4.4	Probe Attenuation and Unit Selection (Volt/Ampere)	16	13.6	UART/RS-232 BUS	52
4.5	Threshold Setting	17	13.7	CAN BUS	53
4.6	Naming a Channel	17	13.8	LIN BUS	55
<b>5</b>	<b>Horizontal System</b>	<b>18</b>	<b>14</b>	<b>Remote Control</b>	<b>57</b>
5.1	Acquisition modes RUN and STOP	18	14.1	USB VCP	57
5.2	Time Base Settings	18	14.2	USB TMC	57
5.3	Acquisition modes	18	14.3	USB MTP	59
5.4	Interlace Mode	21	14.4	Ethernet	60
5.5	ZOOM Function	21	<b>15</b>	<b>Technical Data</b>	<b>63</b>
5.6	Navigation Function	21	<b>16</b>	<b>Appendix</b>	<b>67</b>
5.7	Marker Function	21	16.1	List of figures	67
<b>6</b>	<b>Trigger System</b>	<b>22</b>	16.2	Glossary	67
6.1	Trigger Modes Auto, Normal and Single	22			
6.2	Trigger Source	22			
6.3	Trigger type	22			
6.4	Trigger Events	25			
6.5	External Trigger	25			

# 1 Important Notes

## 1.1 Symbols

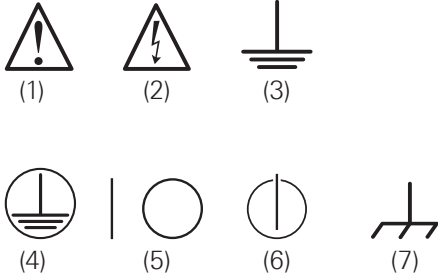

- Symbol 1: Caution, general danger zone – Refer to product documentation
- Symbol 2: Risk of electric shock
- Symbol 3: Ground
- Symbol 4: PE terminal
- Symbol 5: ON/OFF supply voltage
- Symbol 6: Stand by display
- Symbol 7: Ground terminal

## 1.2 Unpacking

While unpacking, check the package contents for completeness (measuring instrument, power cable, product CD, possibly optional accessories). After unpacking, check the instrument for mechanical damage occurred during transport and for loose parts inside. In case of transport damage, please inform the supplier immediately. The instrument must not be operated in this case.

## 1.3 Setting up the instrument

As you can see from the picture, there are small feet on the bottom which can be folded out. Please make sure you have fully folded out the feet's in order to ensure stability of the instrument.

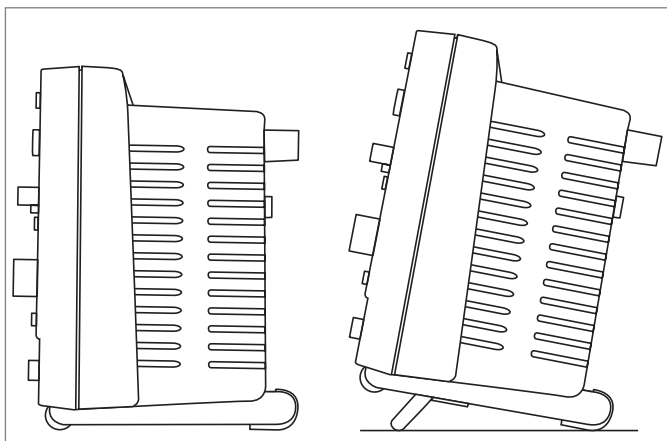

Fig. 1.1: Operating positions

The instrument must be installed in a way, that at any time the disconnection of the power line is not restricted.

## 1.4 Safety

This instrument was built in compliance with DIN EN 61010-1 (VDE 0411 part 1), safety regulations for electrical measuring instruments, control units and laboratory equipment. It has been tested and shipped from the plant in safe condition. It is in compliance with the regulations of the European standard EN 61010-1 and the international standard IEC 61010-1. To maintain this condition and to ensure safe operation, the user must observe all instructions and warnings given in this operating manual. Casing, chassis and all measuring ports are connected to a protective Fig. 1.1: Operating positions earth conductor. The instrument is designed in compliance with the regulations of protection class I. For safety reasons, the instrument may only be operated with authorized safety sockets. The power cord must be plugged in before signal circuits may be connected. Never use the product if the power cable is damaged. Check regularly if the power cables are in perfect condition. Choose suitable protective measures and installation types to ensure that the power cord cannot be damaged and that no harm is caused by tripping hazards or from electric shock, for instance.



**It is prohibited to disconnect the earthed protective connection inside or outside the instrument!**

If it is assumed that a safe operation is no longer possible, the instrument must be shut down and secured against any unintended operation.

### Safe operation can no longer be assumed:

- in case of visible damage,
- in case loose parts were noticed,
- if it does not function any more,
- after prolonged storage under unfavourable conditions (e.g. like in the open or in moist atmosphere),
- After rough handling during transport (e.g. packaging that does not meet the minimum requirements by post office, railway or forwarding agency).

## 1.5 Intended Operation

The measuring instrument is intended only for use by personnel familiar with the potential risks of measuring electrical quantities. For safety reasons, the instrument may only be connected to properly installed safety socket outlets. Separating the grounds is prohibited. The power plug must be inserted before signal circuits may be connected. The product may be operated only under the operating condi-

**Use the measurement instrument only with original ROHDE & SCHWARZ measuring equipment, measuring cables and power cord. Never use inadequately measured power cords. Before each measurement, measuring cables must be inspected for damage and replaced if necessary. Damaged or worn components can damage the instrument or cause injury..**

tions and in the positions specified by the manufacturer, without the product's ventilation being obstructed. If the manufacturer's specifications are not observed, this can result in electric shock, fire and/or serious personal injury, and in some cases, death. Applicable local or national safety regulations and rules for the prevention of accidents must be observed in all work performed.

The measuring instrument is designed for use in the following sectors: industrial sector, home, business and commercial sectors, small businesses. The measuring instrument is designed for indoor use only. Before each measurement, you need to verify at a known source if the measurement instrument functions properly.

**To disconnect from the mains, the low-heat device socket on the back panel has to be unplugged.**

### 1.6 Ambient conditions

The allowed operating temperature ranges from +5 °C to +40 °C (pollution category 2). The maximum relative humidity (without condensation) is at 80%. During storage and transport, the temperature must be between –20 °C and +70 °C. In case of condensation during transportation or storage, the instrument will require approximately two hours to dry and reach the appropriate temperature prior to operation. The instrument is designed for use in a clean and dry indoor environment. Do not operate with high dust and humidity levels, if danger of explosion exists or with aggressive chemical agents. Any operating position may be used; however, adequate air circulation must be maintained. For continuous operation, a horizontal or inclined position (integrated stand) is preferable. The maximum operating altitude for the instrument is 2000m. Specifications with tolerance data apply after a warm up period of at least 30 minutes at a temperature of 23 °C (tolerance  $\pm 2^{\circ}\text{C}$ ). Specifications without tolerance data are average values.



**Do not obstruct the ventilation holes.**

### 1.7 Warranty and repair

ROHDE & SCHWARZ instruments are subject to strict quality controls. Prior to leaving the manufacturing site, each instrument undergoes a 10-hour burn-in test. This is followed by extensive functional quality testing to examine all operating modes and to guarantee compliance with the specified technical data. The testing is performed with testing equipment that is calibrated to national standards. The statutory warranty provisions shall be governed by the laws of the country in which the ROHDE & SCHWARZ



**The product may only be opened by authorized and qualified personnel. Before any work is performed on the product or before the product is opened, it must be disconnected from the AC supply network. Otherwise, personnel will be exposed to the risk of an electric shock.**

product was purchased. In case of any complaints, please contact your supplier.

Any adjustments, replacements of parts, maintenance or repair may be carried out only by authorized ROHDE & SCHWARZ technical personnel. Only original parts may be used for replacing parts relevant to safety (e.g. power switches, power transformers, fuses). A safety test must always be performed after parts relevant to safety have been replaced (visual inspection, PE conductor test, insulation resistance measurement, leakage current measurement, functional test). This helps to ensure the continued safety of the product.

### 1.8 Maintenance

**Clean the outer case of the instrument at regular intervals, using a soft, lint-free dust cloth. Before cleaning the instrument, please make sure that it has been switched off and disconnected from all power supplies. (e.g. mains or battery supply).**

The display may only be cleaned with water or appropriate glass cleaner (not with alcohol or other cleaning agents). Follow this step by rubbing the display down with a dry, clean and lint-free cloth. Do not allow cleaning fluid to enter the instrument. The use of other cleaning agents may damage the labeling or plastic and laquered surfaces.

**Before cleaning the measuring instrument, please make sure that it has been switched off and disconnected from all power supplies (e.g. AC supply network or battery).**

**No parts of the instruments may be cleaned with chemical cleaning agents (such as alcohol, acetone or cellulose thinner)!**

### 1.9 Measuring Category

This oscilloscope is designed for measurements on circuits that are only indirectly connected to the mains or not connected at all. The instrument is not rated for any measurement category. Make sure the entry voltage of the analog channels CH1/CH2 does not exceed 200V (peak value), 150V<sub>RMS</sub> at 1 M $\Omega$  input impedance. The entry voltage of the external trigger input (TRIG. EXT.) does not exceed 100V (peak value). The maximum value allowed for transient overvoltages is 200V (peak value). To ensure compliance, it is necessary to only use probes that have been manufactured and tested in accordance with DIN EN 61010-031 in order to prevent transient overvoltages at the measurement input. The auxiliary output (AUX OUT) is a multi-purpose output with the function as component tester, trigger output, pass/fail and function generator. When performing measurements in category II, III or IV circuits, it is mandatory to insert a probe that reduces the voltage so that no transient overvoltages will be applied to the instrument. Direct measurements (without galvanic isolation) to category II, III or IV circuits are prohibited. The measuring

## Important Notes

Circuits are considered not connected to the mains if an isolation transformer in compliance with class II is used. It is also possible to perform measurements on the mains if appropriate transformers (e.g. current connectors) are used that are in compliance with safety class II. The measurement category (for which the manufacturer specified the required transformer) must be observed.

The measurement categories refer to transients from the power system. Transients are short, very fast (steep) current and voltage variations which may occur periodically and nonperiodically. The level of potential transients increases as the distance to the source of the low voltage installation decreases.

- **Measurement CAT IV:** Measurements at the source of the low voltage installations (e.g. meters)
- **Measurement CAT III:** Measurements in building installations (e.g. power distribution installations, power switches, firmly installed sockets, firmly installed engines etc.).
- **Measurement CAT II:** Measurements on circuits electronically directly connected to the mains (e.g. household appliances, power tools, etc.)
- **0** (instruments without measured measurement category): Other circuits that are not connected directly to the mains.

### 1.10 Mains voltage

The instrument has a wide range power supply from 100 to 240V ( $\pm 10\%$ ), 50 or 60 Hz. There is hence no line voltage selector. The line fuse is accessible on the rear panel and part of the line input connector. Prior to exchanging a fuse, the line cord must be pulled out. Exchange is only allowed if the fuse holder is undamaged. It can be taken out using a screwdriver put into the slot. The fuse can be pushed out of its holder and must be exchanged with the identical type (type informations below). The holder with the new fuse can then be pushed back in place against the spring. It is prohibited to "repair" blown fuses or to bridge the fuse. Any damages incurred by such measures will void the warranty.

#### Type of fuse:

**IEC 60127 - T2.5H 250V** (Size 5 x 20 mm)

### 1.11 Batteries and rechargeable batteries / cells

**If the information regarding batteries and rechargeable batteries/cells is not observed either at all or to the extent necessary, product users may be exposed to the risk of explosions, fire and/or serious personal injury, and, in some cases, death. Batteries and rechargeable batteries with alkaline electrolytes (e.g. lithium cells) must be handled in accordance with the EN 62133 standard.**

1. Cells must not be taken apart or crushed.
2. Cells or batteries must not be exposed to heat or fire. Storage in direct sunlight must be avoided. Keep cells and batteries clean and dry. Clean soiled connectors using a dry, clean cloth.
3. Cells or batteries must not be short-circuited. Cells or batteries must not be stored in a box or in a drawer where they can short-circuit each other, or where they can be short-circuited by other conductive materials. Cells and batteries must not be removed from their original packaging until they are ready to be used.
4. Keep cells and batteries out of the hands of children. If a cell or a battery has been swallowed, seek medical aid immediately.
5. Cells and batteries must not be exposed to any mechanical shocks that are stronger than permitted.
6. If a cell develops a leak, the fluid must not be allowed to come into contact with the skin or eyes. If contact occurs, wash the affected area with plenty of water and seek medical aid.
7. Improperly replacing or charging cells or batteries can cause explosions. Replace cells or batteries only with the identical type in order to ensure the safety of the product.
8. Cells and batteries must be recycled and kept separate from residual waste. Rechargeable batteries and normal batteries that contain lead, mercury or cadmium are hazardous waste. Observe the national regulations regarding waste disposal and recycling.

### 1.12 Product Disposal



Fig. 1.2:  
Product labeling in accordance with EN 50419

The German Electrical and Electronic Equipment (ElektroG) Act is an implementation of the following EC directives:

- 2002/96/EC on waste electrical and electronic equipment (WEEE) and
- 2002/95/EC on the restriction of the use of certain hazardous substances in electrical and electronic equipment (RoHS).

Once its lifetime has ended, this product should be disposed of separately from your household waste. The disposal at municipal collection sites for electronic equipment is also not permitted. As mandated for all manufacturers

by the German Electrical and Electronic Equipment Act (ElektroG), ROHDE & SCHWARZ assumes full responsibility for the ecological disposal or the recycling at the end-of-life of their products.

Please contact your local service partner to dispose of the product.

# 2 Introduction

## 2.1 Front view

On the instrument frontside you can find the power key [1], in order to switch on the instrument or enter stand-by-mode. If the instrument is in stand-by-mode, this key light up red. If the instrument is switched off using the main power switch on the backside, the red light will also switch off (this will take some seconds). Furthermore you find on the front panel the control panel [2], A, B, C, D, the BNC connectors of the analog inputs [45] to [46], the probe adjustment output [49], the bus signal source [48], the connectors for the optional logic probe R&SHO3508 [50], a USB port for USB sticks [52] and the TFT screen [53]. For component and Pass/Fail test use the BNC connector AUX OUT [51].

**Use the connectors for the active logic probes [50] exclusively for the logic probes of type R&SHO3508. Connecting other types may demolish the input.**

## 2.2 Control panel

The controls in the front panel allow access to all basic functions while advanced settings are easily accessible through the menu structure and gray soft menu keys. The power button [1] is clearly set apart by its design. The most significant controls feature colored LEDs, indicating the current setting. The control panel is divided into four sections.

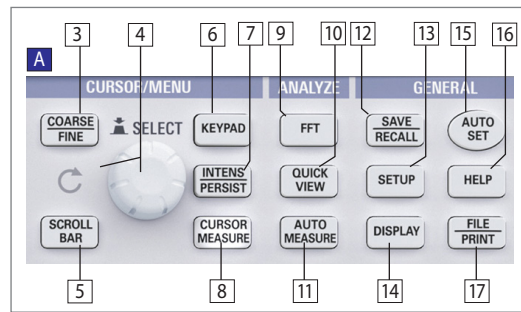

Fig. 2.2: Control panel of section A

### Section A

This section includes the CURSOR/MENU, ANALYZE and GENERAL sections. The CURSOR/MENU section includes cursor functions [8], universal knob [4], Intens/Persist control switch [7] and the option to select the virtual screen [6]. The ANALYZE section allows users to directly access the FFT displays [9], the QUICK VIEW [10] display (all important parameters of the actual signal display), the PASS/FAIL mask test and the AUTO MEASURE settings [11]. The portion Analyze allows direct selection of FFT [9] displays, the Quick view mode [10] (all important parameters of the actual signal display), and the automeasure function [11] for the automatic measurement of parameters. The GENERAL section includes the Save/Recall [12] key. With this option, you can control the settings to load and save instrument settings, reference signals, signals and screen displays.

Additional keys enable the user to access general settings [13] such as language, DISPLAY [14], AUTOSET [15] as well as integrated HELP [16] and FILE/PRINT [17]. Depending on how it is programmed, FILE/PRINT enables you to directly save instrument settings, signals or screen displays.

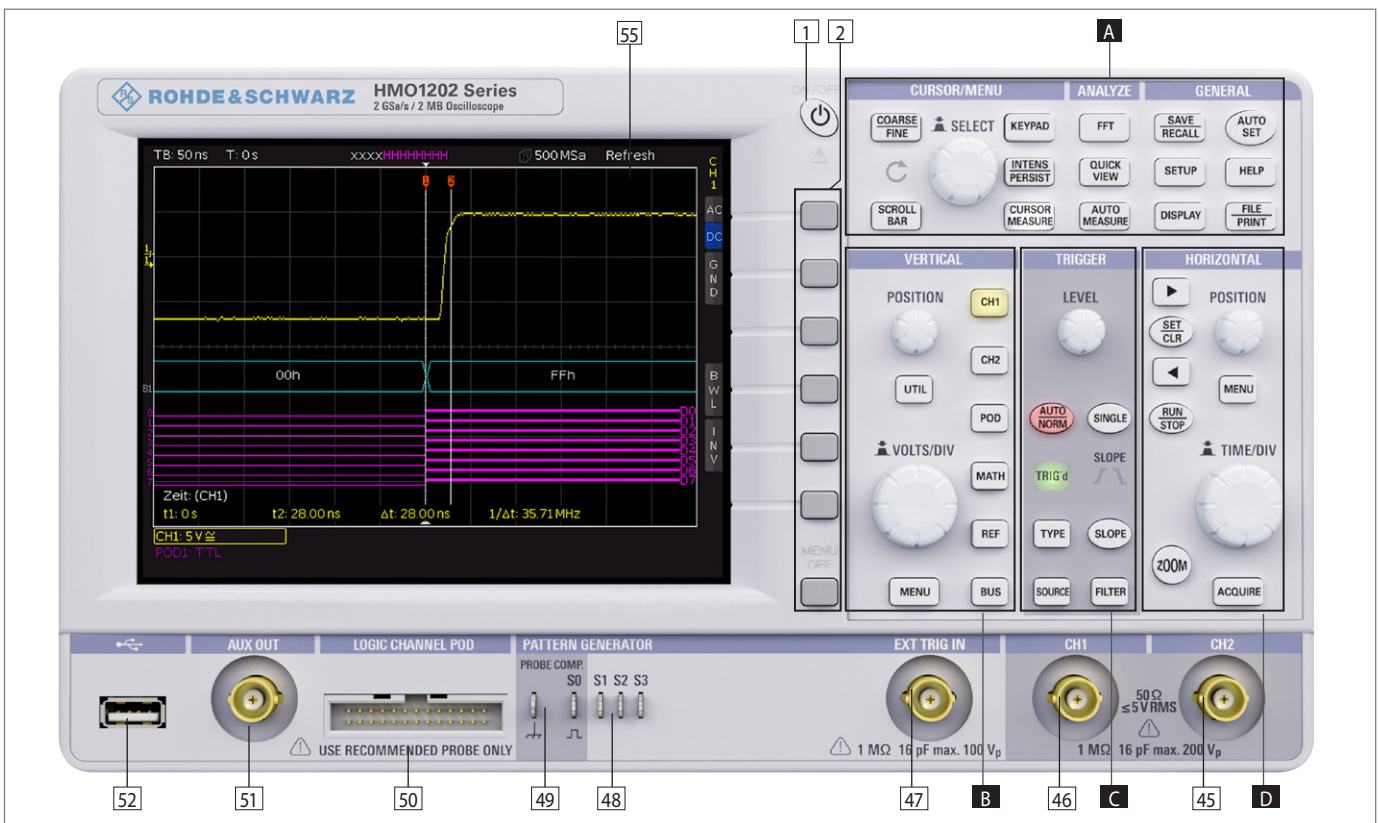

Fig. 2.1: Frontview of the R&S®HMO1202



## Section B:

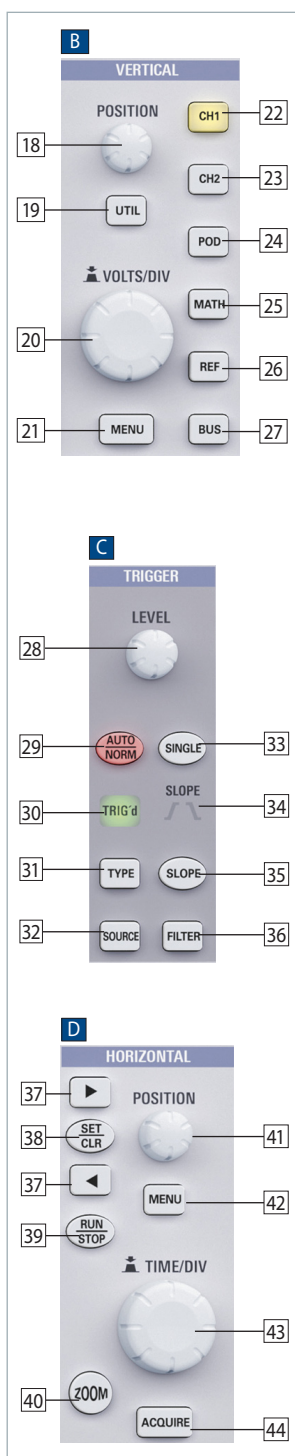

Fig. 2.3: Control panels of sections B, C and D

The VERTICAL section features all controls for analog channels, such as the position control knob [18], the XY and component test mode (UTIL menu) [19], the vertical gain adjustment knob [20], the advanced menu options key [21], the channel select keys [22] to [23] and selection key for the optional logic probe R&SHO3508 [24]. You can also access the MATH key, reference and BUS signal settings key here [27].

## Section C:

The TRIGGER section includes all options to set the trigger level [28], to switch between Auto and Normal mode [29], to set the trigger type [31], the source [32], the single trigger [33], to switch the trigger slope [35] and to set the trigger signal filters [36]. Additionally, you can find status indicators, and you can see if a signal fulfills the trigger conditions [30] and which slope is used [34].

## Section D:

In the HORIZONTAL section, users can shift the trigger position horizontally or set and navigate markers manually, either step-by-step with the keys [37] [38] [39] or alternatively by using the smaller one of the knobs [41]. In the menu, you can also set search criteria for events. The illuminated key [39] allows the selection of the Run and Stop mode. When the stop mode is selected, the key will light up in red. [40] activates the zoom

option, [44] selects the acquisition modes, [43] adjusts the time base speed and [42] enables access to the time base menus. To the left of the control panel, you also find the soft menu keys [2] to control the menu options.

## 2.3 Screen

The R&S®HMO1002 resp. R&S®HMO1202 series is equipped with a 6.5" (16.51 cm) TFT color monitor with LED backlight and VGA resolution (640x480 pixels). In the default setting (no menus shown), the screen includes 12 scale divisions on the time axis. If menus are shown, this will be reduced to 10 divisions. Small arrows on the

left of the display indicate the reference potentials of the channels. The line above the graticule includes status and settings information such as time base, trigger delay and other trigger conditions, the current sampling rate and the acquisition mode. The short menu to the right of the graticule contains the most important settings of the currently active channel. You may select these settings using the soft menu keys. Measurement results for automated measurements and cursors, settings for the activated vertical channels, reference signals and mathematically derived curves are shown in the lower section of the screen. Within the graticule, signals of the selected channels are displayed. By default, 8 scale divisions are shown. This can be extended virtually to 20 divisions which can be displayed using the Scroll/Bar [5] key.

## 2.4 General Operating Concept

The general operating concept is based on a few key principals, recurring with various settings and functions:

- Keys that do not open a soft menu (e.g. SCROLL BAR) activate a specific function; pressing this key a second time will deactivate this function.
- Keys that open a soft menu when pressed once will close the soft menu when pressed a second time.
- Depending on the requirements, the universal knob in the CURSOR/MENU section is designed to either select a numeric value or to navigate through submenus.
- The MENU OFF key below the soft menu keys closes the current menu or switches to the next higher level.
- Pressing the appropriate key will activate a deactivated channel. If a channel was already activated, selecting another channel will change operation to the channel whose key was pressed (its LED lights up).
- If cursor measurements are activated, the COARSE/FINE key will select the cursor with the activated universal knob in the CURSOR/MENU section. This key is used to select or confirm input in all menus for alphanumeric input and for the file manager.

The soft menus include some frequently used navigation elements as described below. You can select the respective element by pressing the corresponding soft menu key, and the element will be marked in blue. Alternatively, you can press the soft menu key to toggle between function options. For functions that need to be activated and require value selections, you may toggle between OFF and the set value (e.g. TIME OFFSET function). The round arrow in the menu window indicates that the value is to be set by means of the universal knob in the CURSOR/MENU control panel. If the respective function includes an additional menu level, it will be indicated by a small triangle on the bottom right of a menu item. If additional menu pages are available, you can navigate these on the same level by using the last menu item. It includes the number of menu pages on this level as well as the current page number. You can advance to the next page by pressing the appropriate soft menu key. Once the last page was listed, the display will loop back to the first page.

## 2.5 Basic Settings and Integrated Help

You can access important basic settings such as language for user interface and help, general settings and interface settings in the menu that opens when you press the SETUP key in the GENERAL section. On the first page of the menu for the basic settings you can select the language for user interface and help. The menu item INTERFACE activates the menus to perform the interface configuration (USB or Ethernet). The menu item PRINTER includes settings for POSTSCRIPT and PCL compatible printers. When pushing this soft menu key, a submenu opens allowing the user to select the paper format and color mode. Using the assigned soft menu key, the top menu item PAPER FORMAT allows you to choose from A4, A5, B5, B6, Executive, Letter and Legal in either portrait or landscape format. Use the universal knob in the CURSOR/MENU section to select the appropriate format. Following the same setup procedure, the menu item COLOR MODE allows you to choose between Grayscale, Color and Inverted. The Grayscale mode converts the color image to a grayscale image which can be printed on a black-and-white postscript printer. The Color mode prints the image in color as shown on the screen (black background). The INVERTED mode prints the color image with a white background on a color printer thus saving toner and ink.

The menu item DEVICE INFORMATION opens a window with detailed information on hardware and software of the measuring instrument. The soft menu key DEVICE NAME allows you to define a name with up to 19 characters which will be listed when screenshots are printed. The soft menu MENU allows you to select whether soft menus are to be closed manually or automatically after 4-30s. Use the soft menu key LOGO IN SCREENSHOT to determine whether the R&S logo displays on the top right corner of printouts or not.

The soft menu UPDATE for the instrument and help update and LICENCES to upgrade software options will be described in detail in the following chapters. The soft menu DATE & TIME is used to set the date and time. The soft menu SOUND is used to set the sound options. You can activate a sound as beeping during setup, in the event of an error and for the triggers.

The integrated help can be activated by pushing the HELP key in the GENERAL section. This opens a window with explanatory text. The text in the help window is dynamically updated with descriptions of the corresponding setting or function. If you no longer require help, push the HELP key to close the HELP option. This will turn the LED indicator for the key off and the text window for the help will close.

## 2.6 Instrument Firmware Update

The R&S®HMO1002 resp. R&S®HMO1202 series is constantly being advanced. You can download the current firmware at [www.rohde-schwarz.com](http://www.rohde-schwarz.com). The firmware is packed in a ZIP file. After downloading the ZIP file, unpack

the data to the base directory of a USB stick. Then connect the USB stick with the USB port of the oscilloscope and press the SETUP key in the GENERAL section of the control panel. The menu item UPDATE can be found on page 2|2. Selecting this menu item opens a window displaying version number, date and build information of the currently installed firmware. Pressing the soft menu key UPDATE the instrument firmware will result in a search for the corresponding file on the USB stick. The information for the new firmware to be installed will then be displayed on the stick below the row labeled NEW:. The version number will be displayed in red in case the existing firmware on the instrument is identical to the latest version; otherwise the version number will be shown in green. Only if this is the case, press the soft menu EXECUTE to start the update.

## 2.7 Options / Voucher

The R&S®HMO1002 resp. R&S®HMO1202 series includes options which allow you to expand the range of application for the instrument (such as bandwidth upgrade or bus analysis functions). At this time, the options R&S®HOO10/HOO11/HOO12 resp. R&S®HOO512/HOO712/HOO572 are available for the R&S®HMO1002 series and the options R&S®HOO10/HOO11/HOO12 resp. R&S®HOO312/HOO313/HOO323 are available for the R&S®HMO1202 series. The bandwidth options R&S®HOO572, R&S®HOO512 and R&S®HOO712, R&S®HOO312, R&S®HOO313 and R&S®HOO323 resp. the bus analysis functions R&S®HOO10, R&S®HOO11 and R&S®HOO12 can be purchased ex factory with the R&S®HMO1002 resp. R&S®HMO1202 series. The bandwidth upgrade vouchers

### Bandwidth Upgrades R&S®HMO1002 Series

Description	Optionen-Code	Voucher-Code
Bandwidth upgrade 50 MHz to 70 MHz	R&S®HOO572	R&S®HV572
Bandwidth upgrade 50 MHz to 100 MHz	R&S®HOO512	R&S®HV512
Bandwidth upgrade 70 MHz to 100 MHz	R&S®HOO712	R&S®HV712

### Bandwidth Upgrades R&S®HMO1202 Series

Description	Optionen-Code	Voucher-Code
Bandwidth upgrade 100 MHz to 200 MHz	R&S®HOO312	R&S®HV312
Bandwidth upgrade 100 MHz to 300 MHz	R&S®HOO313	R&S®HV313
Bandwidth upgrade 200 MHz to 300 MHz	R&S®HOO323	R&S®HV323

### Bus Analysis Options

Description	Optionen-Code	Voucher-Code
I <sup>2</sup> C, SPI, UART/RS-232 on analog and digital channels	R&S®HOO10	R&S®HV110
I <sup>2</sup> C, SPI, UART/RS-232 on all analog channels	R&S®HOO11	R&S®HV111
CAN und LIN on analog and digital channels (only R&S®HMO1002, R&S®HMO1202)	R&S®HOO12	R&S®HV112

Tab. 2.1: Overview R&S®HMO1002/1202 Options / Voucher

- 1) only when ordering with a R&S®HMO1002 resp. R&S®HMO1202
- 2) Activation of R&S®HMO1002/HMO1202 options via upgrade voucher

R&S®HV572, R&S®HV512, R&S®HV712, R&S®HV312, R&S®HV313 and R&S®HV323 and the bus analysis upgrade

vouchers R&S®HV110, R&S®HV111 and R&S®HV112 allow for an upgrade at a later date via licence key. The installed options and vouchers can be verified under DEVICE INFORMATION in the SETUP menu.

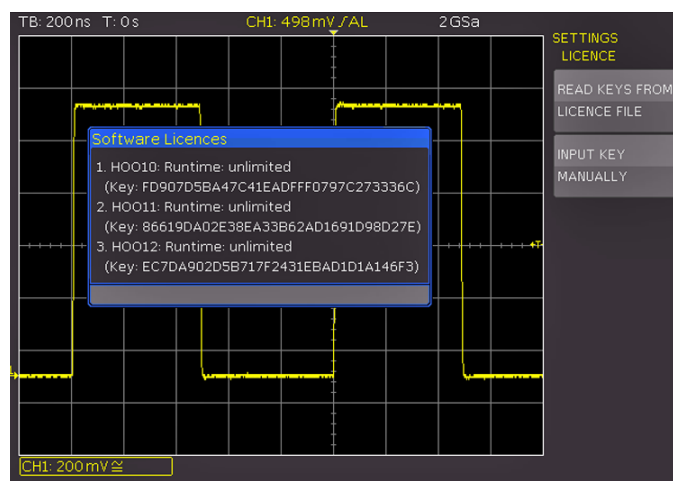

Fig. 2.4: UPGRADE menu

Once you have entered the voucher code on the homepage <http://voucher.hameg.com>, the licence key will be generated („SERIAL NUMBER.hlk“). The ASCII file may be opened with an editor. This allows you to read the actual key in plain text. You can choose between two methods to enable the desired option with this key: an automated reading or manual input. The automated reading via USB stick is the fastest and easiest method. Store the licence file on a USB stick and then install it to the instrument using the FRONT USB port. Press the SETUP key in the GENERAL section of the HMO control panel to open the SETUP menu. You will find the LICENCES menu on page 2|2. Press the soft menu key READ KEYS from licence file to open the file manager. Select the required licence file with the universal knob in the CURSOR/MENU section and then use the soft menu key LOAD to load it. This will load the licence key, making the option instantly available by restarting the instrument.

Alternatively, you can enter the licence key manually. Select the menu UPGRADE and press the soft menu key INPUT KEY manually. This will open an input window. Use

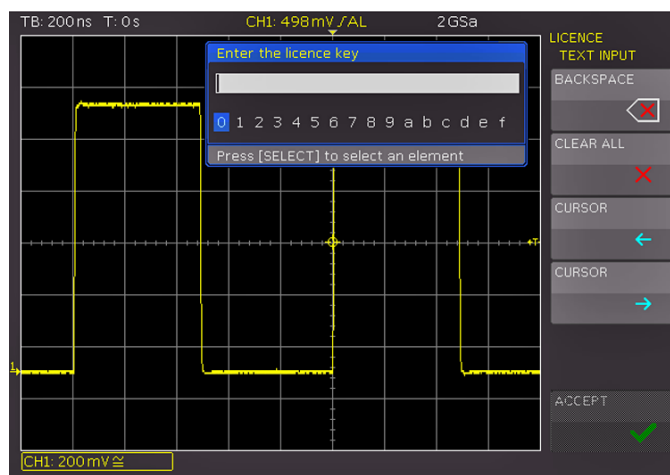

Fig. 2.5: Manual input of the licence key

the universal knob in the CURSOR/MENU section and the ENTER key to enter the licence key manually. After entering the complete key, press the soft menu key ACCEPT to confirm the entry. The option will be activated after restarting the instrument.

The R&S®HMO1002 resp. R&S®HMO1202 series is prepared for mixed-signal operation and have the appropriate connectors on the front panel. Connecting an 8-channel logic probe R&S®HO3508 equips the scope with 8 logic channels.

## 2.8 Self Alignment

**The instrument must have reached the required operating temperature (switched on for at least 20 minutes) and all inputs must be unused, in other words all cables and probes must be removed from the inputs.**

The R&S®HMO1002 resp. R&S®HMO1202 series features an integrated self alignment procedure to achieve the highest possible accuracy. During the standard self alignment the instrument adjusts vertical accuracy, offset, time base and several trigger settings and saves the identified correction data internally. To start the self alignment in the SETUP menu, press the soft menu key SELF ALIGNMENT and press the START key. The procedure will run for about 5-10 minutes. Each step and its corresponding progress will be shown in a bar display.

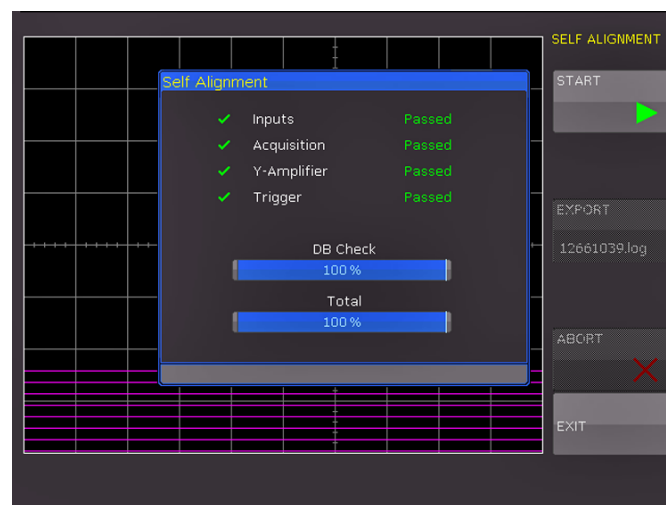

Fig. 2.6: Self alignment successful

**If an error occurs during the self alignment although it has been carried out as described, please send the exported .log file (see Self Alignment menu) to [customersupport@rohde-schwarz.com](mailto:customersupport@rohde-schwarz.com). You can save the .log file to a USB stick.**

### 2.8.1 Logic Probe Self Alignment

The self alignment for the optional logic probe R&S®HO3508 primarily aligns the switching levels. To start the self alignment for the logic probe, it is necessary that the logic probe type R&S®HO3508 is connected to the R&S®HMO1002 resp. R&S®HMO1202 series. It is imperative that the bit connectors are not connected. To start the

## Introduction

process, select the menu item LOGIC PROBE in the SELF ALIGNMENT soft menu. The process is similar to the basic instrument alignment but it only takes a few seconds.

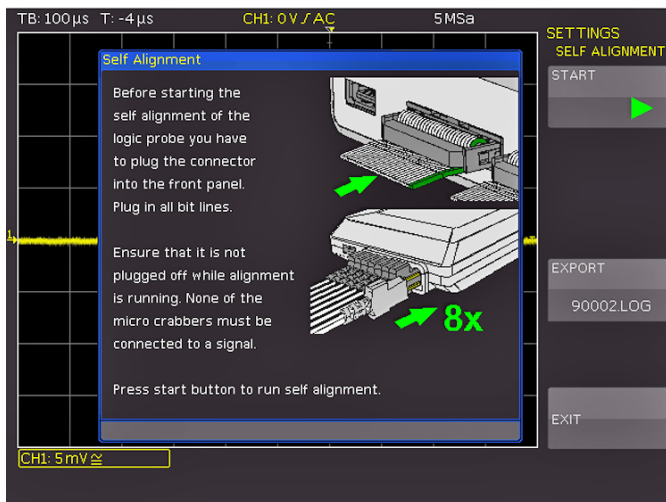

Fig. 2.7: Self alignment logic probe

## 2.9 Education Mode

The education mode allows you to deactivate the AUTO-SET, QUICK VIEW and Auto measuring functions. When this mode is activated (function is marked in blue), a

message will display on the screen. In addition, the home screen, the instrument information and a screenshot will indicate that the education mode has been activated. To deactivate this mode, press the soft menu key EDUCATION MODE again, and the blue marking will disappear.

## 2.10 Back Panel of the Instrument

On the back panel of the instrument, you will find the Ethernet/USB interface which is permanently installed in the instrument. Optional interfaces are not available.

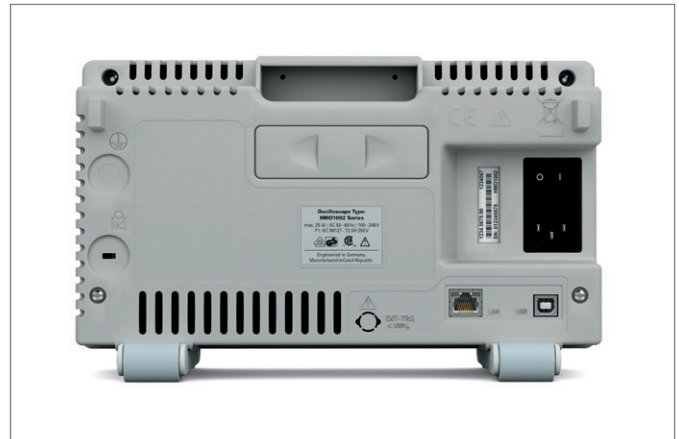

Fig. 2.8: Back panel

# 3 Quick Start Guide

The following chapter is an introduction to the most important R&S®HMO1002 resp. R&S®HMO1202 series features and settings allowing you to use the instrument promptly. The integrated calibrator signal output is used as the signal source which means that the first steps will not require any additional instruments.

## 3.1 Setting up and turning the instrument on

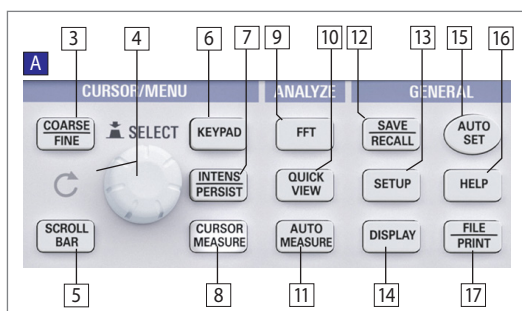

Fig. 3.1: Control panel of section A

To optimally set up the instrument, position the handle so that the display will be inclined slightly upwards. Plug the power cord into the rear panel conn[1] on the front panel. The display appears after a few seconds, and the oscilloscope is ready for operation. Press the AUTOSET key [15] until a beep. This will reset the most important oscilloscope settings to their default settings.

## 3.2 Connection of a probe and signal capture

**Make sure to align the passive probes prior to their first use. For more information, please refer to the probe manual. Place the probe in the appropriate position on the ADJ. output.**

Take one of the provided probes and remove the protective cap from the tip. Apply the probe compensation box to the BNC connector for channel 1 and turn it to the right until it latches into place. On the right hand side of the screen, you will see the short menu for channel 1. Press the soft menu key to the right of each menu item to select frequently used settings. Press the top soft menu key to change the input coupling to

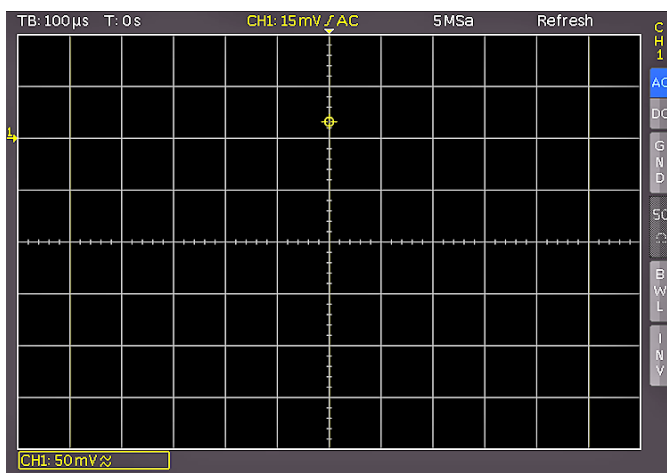

Fig. 3.2: Screen display after connection of the probe

DC. Briefly press the AUTOSET key once [15].

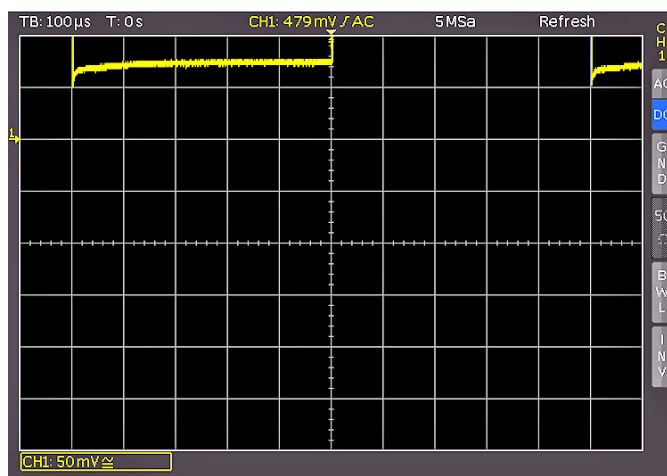

Fig. 3.3: Screen display after changing to DC coupling

After a few seconds, the oscilloscope will have automatically selected the sensitivity, time base and trigger settings. A square wave signal will now be shown.

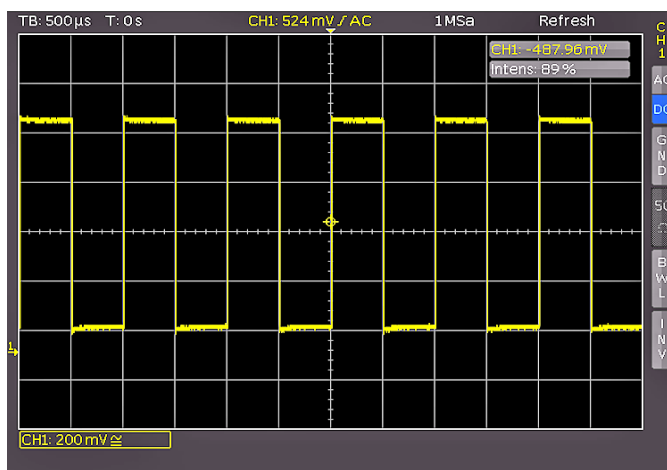

Fig. 3.4: Screen display after Autosetup

## 3.3 Display of signal details

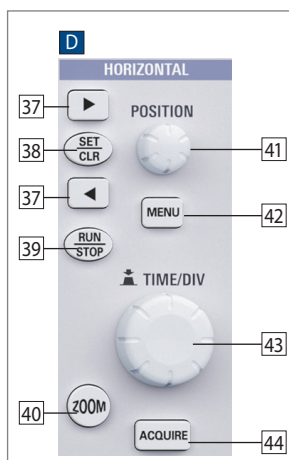

Fig. 3.5: Section D of the control panel with zoom key

With the time base knob [43] you can change the displayed time window. Turning it CCW increases the time base. Continue to turn the knob CCW until you can read "TB:5ms" in the upper left corner of the screen. Press the ZOOM key [40]. You will see the two window display: The upper section of the window displays the entire captured signal whereas the lower section shows an enlarged section. Use the time base knob to select the zoom factor. The small knob

allows you to determine the horizontal position of the section. Press the ZOOM key [40] again to deactivate the zoom mode.



### 3.6 Mathematical functions

In addition to cursor and automatic measurements, the R&S®HMO1002 resp. R&S®HMO1202 series can also apply mathematical operations to the signals. Pressing the MATH  $\square$  key opens a menu enabling you to apply addition, subtraction, multiplication or division to two analog channels. This also displays the mathematical graph. The top soft menu key allows you to select the first operand. With the key below, you can select the operator. The soft menu key below that allows you to select the second operand. Only activated and displayed channels are available for the operands. The sources selected in the function must be activated so that the mathematical graph can be calculated and the result signals can be displayed.

### 3.7 Storing data

The R&S®HMO1002 resp. R&S®HMO1202 series is able to store 4 different types of data:

- ▮ Device settings
- ▮ Reference signals
- ▮ Traces
- ▮ Screenshots

Out of these data types, signals and screen displays can only be stored on a USB stick. All other data types can be stored on a USB stick or internally in the instrument to non-volatile storage media. To store data you have to define the data type and the destination to be used for storing. First attach a USB stick to the front USB connector of your oscilloscope. Press the Save/Recall  $\square$  key to open the respective menu. Select the type of data you wish to store by pressing the respective soft menu key (in this example SCREENSHOTS). This will open the settings menu. In the top menu make sure that Storage Front is selected. Press the soft menu key to open the menu where you can select these settings. It is important to connect a USB stick with the front USB connector of your oscilloscope which must be recognized by your instrument. Pressing the soft menu key SAVE allows you to save a screenshot using the default file name (the current file name is displayed in the menu item FILE NAME). You can also select a name for the target file with up to 8 characters. Select the menu item FILE NAME and use the universal knob to enter the name (in this example "TRC").

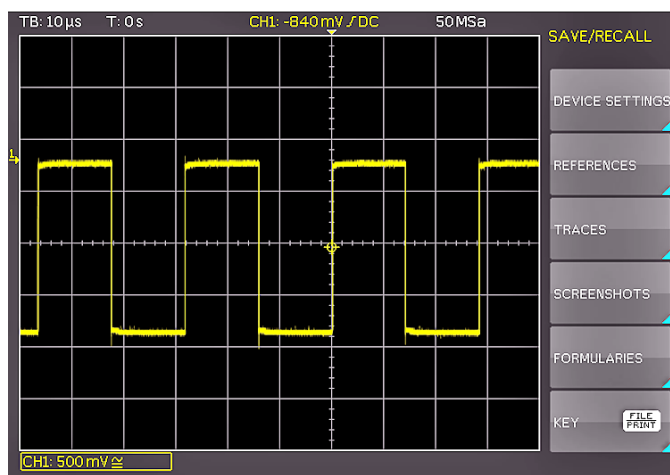

Fig. 3.9: Save/Recall menu

Press the soft menu key ACCEPT. The oscilloscope accepts the name and returns to the settings menu. Here you can store the current image by pressing the soft menu key SAVE. Alternatively, you can move up one level in the menu by using the OFF key on the bottom and select the menu item FILE/PRINT. In the following menu press the soft menu key SCREENSHOTS. This will assign the function Screenshot to the FILE/PRINT  $\square$  key with the selected settings. This enables you to generate a screenshot on your USB stick by pressing the FILE/PRINT key at any given time using any menu.

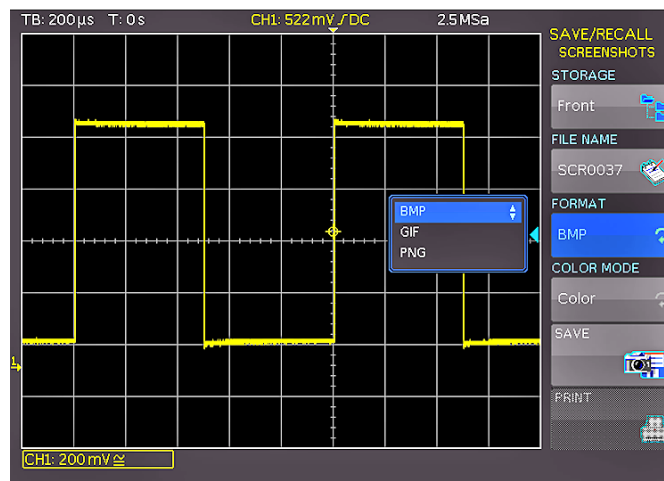

Fig. 3.10: Screenshot menu

# 4 Vertical System

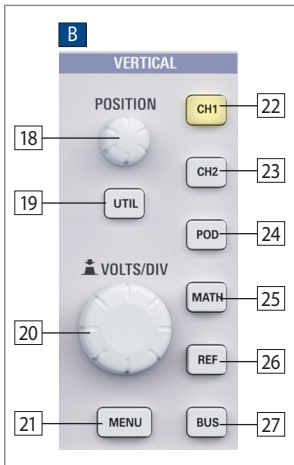

Fig. 4.1: Control panel for the vertical system

You can select vertical settings using knobs for the vertical position and the sensitivity. You may also use a menu that is permanently displayed as well as an advanced menu. You can select for which channel you want the settings to be activated by pressing the respective channel key. Once a channel has been activated, the key will be marked by a colored LED light. Additionally, the screen display will include a frame around the activated channel with a frame and a color brighter than that of deactivated channels. The corresponding short menu is always visible and you can push the Menu [21] key to activate the advanced menu.

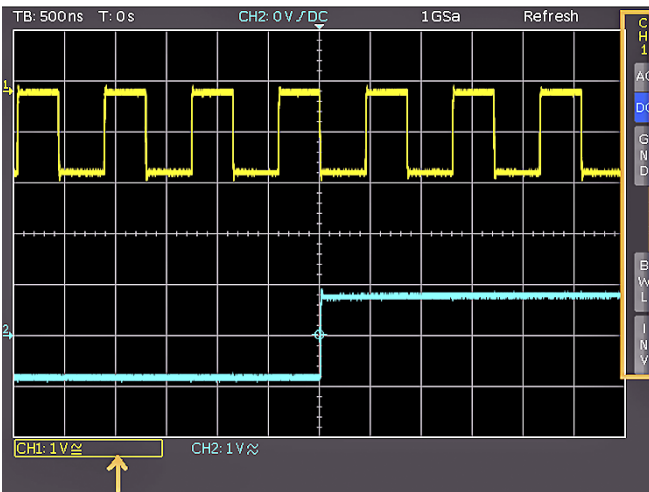

Fig. 4.1: Short menu for vertical settings

## 4.1 Coupling

The analog channels have an input impedance of 1 M $\Omega$  or 50 $\Omega$  with the R&S®HMO1202 series. The R&S®HMO1002 series have only an input impedance of 1 M $\Omega$ .

**Do not connect the 50 $\Omega$  inputs to effective voltage higher than 5V.**

The 50 $\Omega$  input impedance should only be selected if the signal source is 50 $\Omega$ , e.g. a generator with a 50 $\Omega$  output where the termination within the scope is to be used. In all other cases 1 M $\Omega$  is to be selected. The user determines if DC coupling or AC coupling is to be used. With DC coupling, the DC voltage of the signal will be displayed. With AC coupling, an input filter of 2 Hz suppresses the display of DC voltage. Signals of up to 200V (peak value) may be connected directly to 1 M $\Omega$  inputs. Higher voltages can be measured with external probes (up to 40kV peak voltage). This should only be used with DC coupling. For all general applications, the probes supplied with the ins-

trument will be used. With the R&S®HMO1002 series the HZ154 probe is included in delivery which offers 10:1 / 1:1 switchable attenuation. The attenuation setting has to be set manually in the channel menu. The R&S®HMO1202 series is delivered with the RT-ZP03 probe.

You can set the coupling using the short menu or channel menu. Simply press the respective soft menu key to set the coupling and the graphic inversion of the input channel. The menu applies to the corresponding active channel. The illuminated channel key indicates which channel is active. You can switch between channels by pressing the respective channel key.

## 4.2 Sensitivity, Y Positioning and Offset

You can select the sensitivity of the analog inputs by using the knob in the VERTICAL section (VOLTS/DIV) in 1-2-5 steps of 1mV/div to 10V/div. The knob is associated with the active channel (push the respective channel key to activate the desired channel). Pushing the knob once will switch to a continuous sensitivity setting. You can use the smaller knob in the VERTICAL section (POSITION) to determine vertical settings for the active channel. Press the MENU key to access advanced options. On page 2|2 of this menu, you can add a DESKEW. To activate this offset push the corresponding soft menu key. You can set the offset value using the universal knob or the KEYPAD key in the CURSOR/MENU section. Each analog channel may be shifted in time by  $\pm 32$  ns. This deskew setting is used to compensate different signal delays when using different cable lengths or probes.

## 4.3 Bandwidth Limit and Signal Inversion

Both the short menu and the advanced menu enable you to insert an analog 20 MHz low pass filter to the signal path. This will eliminate all higher frequency interference. To activate the filter in the short menu, press the respective soft menu key BWL. In the advanced channel MENU the bandwidth limit will be set with the soft menu key BANDWIDTH. Once the filter is activated, the menu item will be marked in blue, and the identifier BWL will be displayed in the channel information window. Signal inversion is available in the short menu and the advanced menu in the VERTICAL section. An activated filter will be indicated in blue in the menu and by a bar above the channel name in the channel name window.

## 4.4 Probe Attenuation and Unit Selection (Volt/Ampere)

The R&S®HMO1002 resp. R&S®HMO1202 series does not include an integrated probe attenuation detection. You can manually set the attenuation factor in the advanced MENU in the VERTICAL section. This is possible with the predefined steps x1, x10, x100, x1000 or, using the universal knob or the KEYPAD key, as defined by the user from x0.001 to x1000. In this menu, you can also select the unit Ampere in case you are using a current probe. If you select the unit Ampere (A), the menu shows the most common factors (1V/A, 100mV/A, 10mV/A, 1mV/A). You may also



use the USER setting to select any given value. You can set the value using the universal knob or the KEYPAD key in the CURSOR/MENU section. This setting may also be used to measure the voltage via shunt. All measurements are always displayed with the correct unit and scale.

#### 4.4.1 Probe Compensation

**Make sure to align passive probes prior to their first use, after an extended measurement break, or when switching instruments or channels.**

You can perform the probe compensation via compensation wizard or manually. To open the wizard, press the SETUP key in the GENERAL section, and then press the soft menu key PROBE COMP. This compensation wizard will guide you through all the important points of the probe compensation. After connecting a probe, you can select the respective analog channel via soft menu key CHANNEL 1 (CH1) or CHANNEL 2 (CH2). The enclosed probe stylus allows you to set the probe trimmers to an optimal square wave shape.

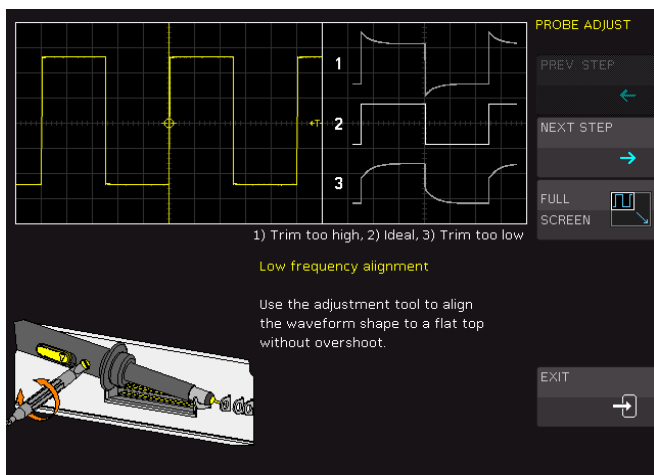

Fig. 4.2: Probe compensation wizard

The compensation is performed at 1 kHz (LF) and 1 MHz (HF). Use the soft menu FULL SCREEN to hide the wizard help entries. Select NEXT STEP to toggle the wizard into the 1MHz HF compensation. If multiple probes are connected, you can switch the channel via soft menu key NEXT CHANNEL. Use the EXIT option to exit the wizard after a successful probe compensation. If you would like to perform a manual compensation without the compensation wizard, choose the UTIL menu in the Vertical control panel, then select the soft menu key PATTERN GEN. in the soft menu SQUARE WAVE (see chapter 10.2.1).

#### 4.5 Threshold Setting

On page 2|2 in the advanced MENU in the VERTICAL section you can set a THRESHOLD. This threshold defines the level to detect a High or a Low if analog channels are used as source for the serial bus analysis or logic trigger. After selecting this soft menu item, you can set the threshold using the universal knob or the KEYPAD key. With the soft menu key HYSTERESIS a range around the trigger threshold level can be set. If the signal jitters inside

this range and crosses the trigger level thereby, no trigger event occurs. With FIND LEVEL will automatically analyze the signal and find an appropriate level.

#### 4.6 Naming a Channel

The last entry NAME in the VERTICAL menu opens a submenu which allows you to enter a channel name. This name will be displayed on the grid and the printout. Your first option is to switch the display on (ON) or off (OFF). The next option includes the menu item LIBRARY. After selecting this option, you can use the universal knob to choose a name from several suggestions. The EDIT LABEL key allows you to enter a completely new name or to customize the suggested name. You may enter up to 8 characters. Use the ACCEPT key to confirm the name in the editor. It will then be shown in the display. The name is assigned to that specific signal and will move alongside any set offset value.

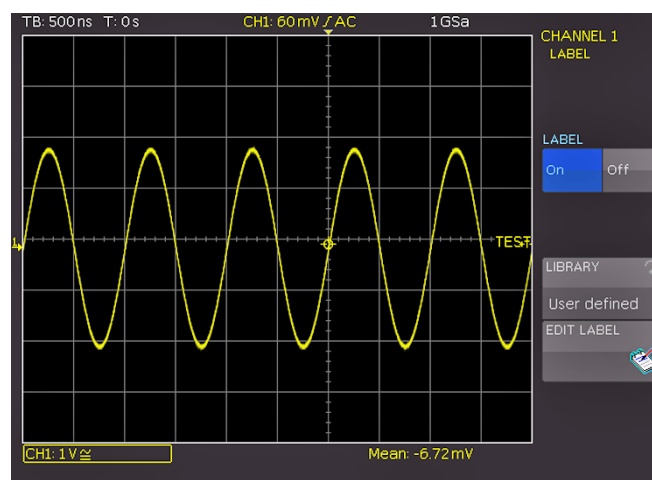

Fig. 4.3: Name selection

# 5 Horizontal System

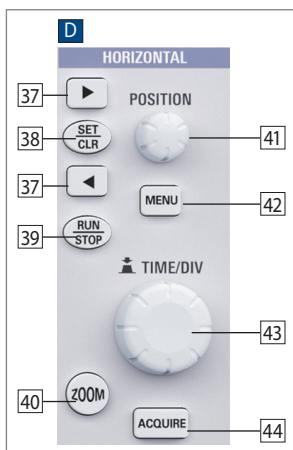

Fig. 5.1: Control panel of the horizontal system

In the HORIZONTAL system section, users can select time base settings for capturing, trigger time position, zoom functions, acquisition modes, marker functions and search functions. Knobs allow you to set time base and trigger time position. A menu enables you to select the desired acquisition mode. A separate key is available to activate the zoom. Use the arrow keys ◀▶ [37] and the SET/CLR key to select marker functions.

## 5.1 Acquisition modes RUN and STOP

The acquisition mode can be selected with the RUN/STOP key [39]. In Run mode signals are shown on the screen according to the selected trigger conditions, discarding previously captured signals with each new capture. If you wish to analyze a captured signal on the screen without overwriting it, capture must be stopped by pressing the RUN/STOP key. While in STOP mode, you may not capture new signals and the key is illuminated in red.

## 5.2 Time Base Settings

The TIME/DIV knob in the HORIZONTAL section of the control panel is used to change the time base. The current time base setting (e.g. "TB: 500 ns") is displayed in the upper right above the graticule. To the right of the display you can see the trigger time position in relation to the default setting. The default setting shows the trigger time position in the center of the display, with 50% of the signal display before and 50% after this trigger position. The X-POSITION knob [41] allows continuous adjustment of the x position. The maximum values allowed depend on the time base setting.

Pushing the SET/CLR key resets the value to its reference position as long as the marker or search functions have not been applied. The arrow keys ◀▶ [37] allow you to change the X position by a fixed amount of 5 divisions in the respective direction. The MENU [42] key opens a menu to determine the function for the arrow keys ◀▶ [37] and the SET/CLR key. As described above, these keys allow you to set the X position. Alternatively, you can use them to mark events within the signal with the option to navigate between up to 8 markers. In the submenu NUMERIC INPUT you can enter any horizontal position directly. This menu also allows you to activate and set search functions. You can also set the TIME REFERENCE (position for the trigger reference point, from -6 divisions to +6 divisions with 0 being the center and default setting).

## 5.3 Acquisition modes

The acquisition modes are selected by pressing the ACQUIRE [44] key. This opens a display menu which offers the following acquisition modes:

### 5.3.1 Roll

This acquisition mode is intended specifically for very slow signals, with the untriggered signal „rolling“ across the screen from right to left (requires signals slower than 200 kHz). The R&S®HMO1002 resp. R&S®HMO1202 series uses a ring buffer to store the signal values in roll mode. Simply put, the instrument writes the first division to the first storage space, the second division to the second storage space, etc. Once the storage is full, the instrument overwrites the first storage space with the data of the most recent measurement value. This creates a „ring“ or cycle run, similar to a ticker.

**The ZOOM feature is not available in the roll mode (also refer to Chap. 5.5 ZOOM Function)**

### 5.3.2 Arithmetic

The soft menu ARITHMETIC offers following menu items:

#### ■ REFRESH:

This mode allows the capture and display of current signals.

#### ■ ENVELOPE:

In this mode, the display includes the normal capture of each signal and the maximum as well as the minimum values of each capture. Over time, this creates an envelope surrounding the signal.

#### ■ AVERAGE:

In this mode, you can use the universal knob in the Cursor/Menu section of the control panel to set the number of signal periods for averaging, available in powers of 2 from 2 to 1024 (requires repetitive signals).

#### ■ SMOOTH:

The function SMOOTH is used to calculate the mean value from several adjacent sampling points. The result is a smooth waveform. This function is used for non-periodic signals.

#### ■ FILTER:

In this mode, you can activate a low pass filter with adjustable cut off frequency to suppress unwanted high frequency interferences. The cut off frequency can be set based on the sampling frequency. The minimum setting is 1/100 of the sampling frequency and the maximum value is 1/4 of the sampling rate. You can select this setting with the universal knob.

### 5.3.3 Peak Detect

This mode is used for very large time base settings to detect even short signal changes. You can also deactivate this function within the menu (OFF) or you can select the automatic switching mode (AUTO). The following conditions must be met to activate the PEAK DETECT mode:

- Function HIGH RESOLUTION is deactivated
- None of the serial or parallel buses are active

During peak detection, the oscilloscope distinguishes between two types:

#### ■ Acquisition peak detection:

Each A/D converter converts at the full sampling rate (no Interlace mode), even if results have not been written to the acquisition memory at full sampling rate (for slow time bases, for instance). If peak detection is activated, unused converter values will be evaluated to detect minimum and maximum amplitudes. During this process, the identified minimum and maximum values including sampling interval are written to the acquisition memory. As a result, the acquisition memory stores data pairs representing the signal sequence according to the sampling interval. The smallest detectable pulse is the period of the maximum sampling rate (no Interlace mode). This describes the so-called acquisition peak detection.

#### ■ Memory peak detection:

A hardware peak detection is not available if data is written to the acquisition memory at the ADC's maximum sample rate. For slow time bases and the record mode is set to AUTOMATIC or MA.WFM.RATE, not all data from the acquisition memory will display on the screen. With peak detection activated when reading out, skipped data will be used to create a minimum and maximum value. The smallest detectable pulse is the period of the sample rate used to write to the acquisition memory. This describes the so-called memory peak detection.

If one of the peak detection modes or a combination of the two are used, the corresponding detection mode is marked with „PD“ in the upper right of the display.

### 5.3.4 High Resolution

This mode uses Boxcar Averaging via adjacent detection points (i.e. the converter runs at the maximum sampling rate) to increase the vertical resolution to up to 16 bit. You can deactivate this function within the menu (OFF) or you can select the automatic switching mode (AUTO).

Averaging several adjacent sampling rates creates a value with a higher degree of accuracy than the input data. The resulting data is called high resolution data. The process of merging multiple sampling rates to one new value only allows a sampling rate that is smaller than the maximum value. If the HIGH RESOLUTION mode is activated and the current instrument setting allows the use of the HIGH RESOLUTION mode, the detection mode is marked with „HR“ in the upper right of the display.

The following requirements must be met to activate the HIGH RESOLUTION mode:

- Sampling rate is smaller than the maximum sampling rate (no Interlace mode)
- Peak detection is deactivated
- No active logic pod
- None of the serial or parallel buses are active

By default, all functions listed above are deactivated.

### 5.3.5 Interpolation

With the soft menu item INTERPOLATION users can select Sinx/x, Linear or Sample-Hold as interpolation type to display acquired data points. The default setting is Sinx/x interpolation which is the best option for displaying analog signals. Linear interpolation (LINEAR) uses a line to connect acquired data points. SAMPLE-HOLD allows a more precise assessment of the position for the acquired data points.

### 5.3.6 Record Mode

This soft menu item provides the following functions:

#### 5.3.6.1 MAX. WFM.-RATE

This mode allows you to select the memory depth and sampling rate to obtain the maximum trigger repeat rate. This mode allows you to select the memory depth and sampling rate to obtain the maximum trigger repeat rate. When using the MAX. WAVEFORM RATE mode, the oscilloscope is set to display the maximum amount of captures per second in the signal window. Each column in the signal window displays a captured date. When peak detection is activated, each column displays a pair of min/max values. The R&S®HMO1002 resp. R&S®HMO1202 series displays a signal window of 600x400 pixels (Yt without zoom). This translates into 600 data points per detection. When peak detection is activated, 600 pairs of min/max values or 1,200 data values are displayed. The memory depth corresponds to at least the displayed time window (time base x signal window grid section in horizontal direction) multiplied by the current sampling rate. The minimum value is determined by the maximum sampling rate and the maximum signal repeat rate of the oscilloscope. The displayed sampling rate corresponds to the current sampling rate divided by the amount of data skipped while reading out from the acquisition memory. If peak detection is activated, the displayed sampling rate corresponds to the current sampling rate.

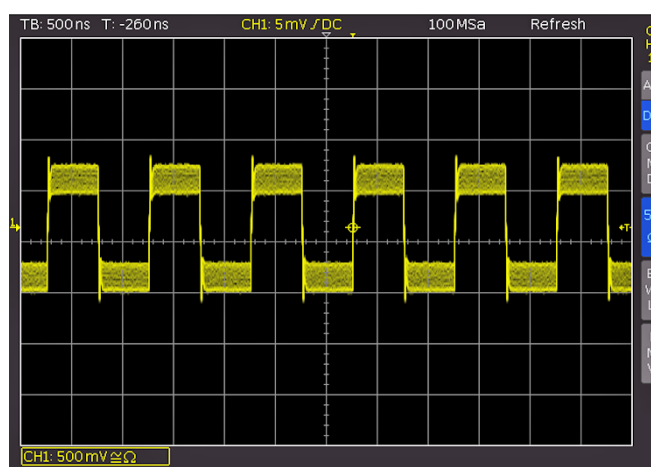

Fig. 5.2: AM modulated signal with maximum repeat rate

#### 5.3.6.2 MAX. SA. RATE

If this function is activated, the instrument always sets the maximum sampling rate while using the maximum memory available. The MAX. SAMPLE RATE function always uses the maximum sampling rate and displays

**The entire oscilloscope memory can only be read out in STOP mode if the maximum sampling rate has been activated.**

the maximum amount of data. Each column in the signal window displays up to 40 detected data values (limited by processor performance). How much data is currently displayed depends on the displayed time window and the current sampling rate. If peak detection is activated, each column displays up to 20 pairs of min/max values. The memory depth always corresponds to the maximum acquisition memory. The displayed sampling rate is identical with the current sampling rate. Peak detection is used if the displayed time window contains more data than 40 \* signal window columns in the acquisition memory or min/max data in the acquisition memory.

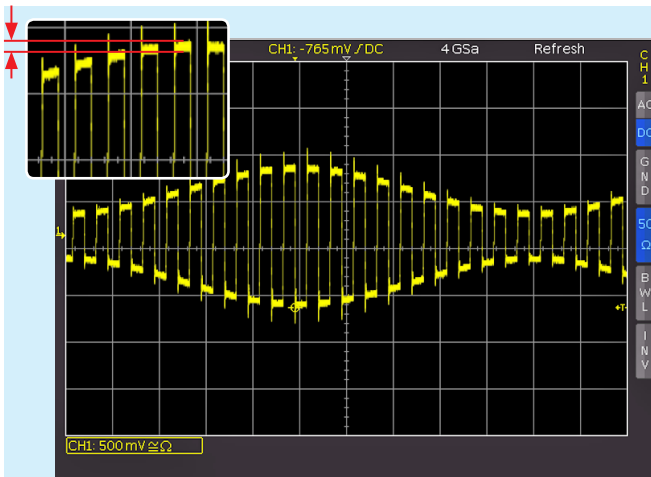

Fig. 5.3: Example figure of AM modulated signal with max. sampling rate

**5.3.6.3 AUTOMATIK**

This function is the default setting and offers the best compromise between maximum repeat rate and maximum sampling rate (selection of memory depth). Each column in the signal window displays up to 10 captured data values. How much data is currently displayed depends on the displayed time window and the current sampling rate. When peak detection is activated, each column displays up to 5 pairs of min/max values. The memory depth is at least twice as much as the storage capacity set for the maximum repeat rate (limited by the maximum acquisition

memory). The displayed sampling rate corresponds to the current sampling rate divided by the amount of data skipped while loading from the acquisition memory. If peak detection is activated, the displayed sampling rate corresponds to the current sampling rate.

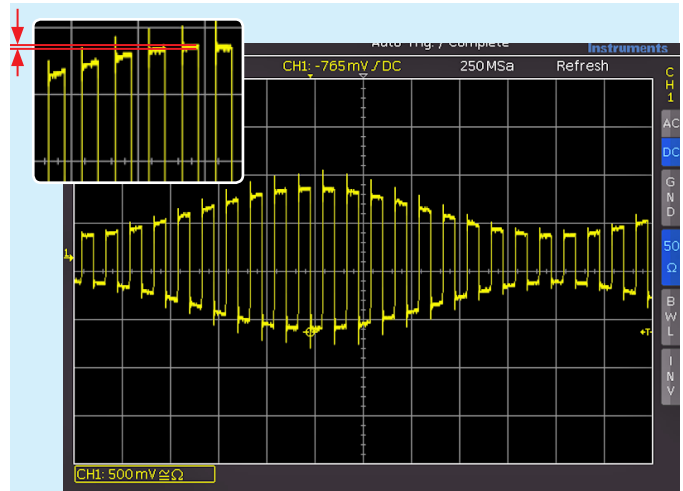

Fig. 5.4: Example figure of AM modulated signal with automatic setting

All settings apply the identical current sampling rate (sampling rate used to write to the acquisition memory). In STOP mode it is also possible to change menu items. This does not impact the current memory depth but the amount of displayed data will be adjusted. Peak detection is also activated in STOP mode (time base in microseconds). In time bases displaying each sampling point, all three settings behave identically (except used memory depth and signal update rate). Table 5.1 displays advantages and disadvantages of each setting. Finally, it needs to be mentioned that this menu replaces the adjustable memory depth, a standard for other manufacturers. An adjustable memory depth is intended to allow users to understand the relation between memory depth, time base and sampling rate and to evaluate advantages and disadvantages. With this option, the oscilloscope always captures signals with the maximum sampling rate. This allows users in STOP mode to zoom in retrospectively, even at the maximum repeat rate. It is also possible to zoom out at the maximum repeat rate if the STOP mode was run at fast time bases. If a high repeat rate can only be attained

Setting	Advantages	Disadvantages	Application
Maximum waveform rate:	<ul style="list-style-type: none"> <li>Many captures in one image</li> <li>Rare events can be detected more quickly in connection with persistence</li> <li>Quick response to Operation or change in signal</li> <li>Low noise band</li> </ul>	<ul style="list-style-type: none"> <li>High aliasing risk</li> <li>Low accuracy of details</li> <li>Low accuracy of measurements due to reduced amount of data</li> </ul>	<ul style="list-style-type: none"> <li>Search for rare events</li> <li>Displaying modulated signals</li> </ul>
Maximum sample rate	<ul style="list-style-type: none"> <li>Maximum accuracy of details</li> <li>Lowest aliasing risk</li> <li>High accuracy of measurements</li> </ul>	<ul style="list-style-type: none"> <li>Slow response to operation or change in signal</li> <li>Low signal update rate</li> <li>Higher visibility of noise</li> </ul>	<ul style="list-style-type: none"> <li>For signals with high frequency parts</li> <li>Assessment of small signal details</li> </ul>
Automatik:	<ul style="list-style-type: none"> <li>Average signal update rate</li> <li>Reasonably smooth operation</li> <li>Good accuracy of measurements</li> <li>Low noise band</li> </ul>	<ul style="list-style-type: none"> <li>Possible aliasing</li> </ul>	<ul style="list-style-type: none"> <li>Default application</li> </ul>

Table 5.1: Advantages and disadvantages of each setting.

by means of low memory depth (as is the case with other manufacturers) it is nearly impossible to zoom in retrospectively in STOP mode.

## 5.4 Interlace Mode

In interlace mode, ADC and storage of two channels are connected. This doubles the sampling rate and the acquisition memory. A channel is considered active even if it has been deactivated while still serving as the trigger source. If a channel is activated, the respective LED next to the input connector is illuminated. The following conditions must be met to activate the Interlace mode:

- No active logic pod
- None of the serial or parallel buses are active
- Logic trigger not active

The interlace mode will be activated automatically.

## 5.5 ZOOM Function

The R&S®HMO1002 resp. R&S®HMO1202 series features a memory depth of 1 MSa resp. 2 MSa. This allows the user to record long and complex signals which can be analyzed in full detail with the Zoom function. To activate this feature, press the ZOOM key [40]. The screen will be divided into two sections. The upper window displays the entire time base window whereas the lower graticule shows an enlarged section of the upper window. The enlarged signal section is marked by two blue cursors in the original signal (upper window). If several channels are activated in Zoom mode, all displayed channels will be zoomed simultaneously by the same factor and at the identical position. Fig. 5.5 displays the Zoom window with 100  $\mu$ s per division. The signal was captured within a time window of 12ms. The zoom area (lower grid) also displays the parameter for zoom time base whereas time is displayed above the zoom window. Z indicates the zoom time base (zoom factor) and determines the width of the zoom area displayed in the zoom window (10 divisions x scaling per division). Tz indicates the zoom time and determines the position of the zoom area.

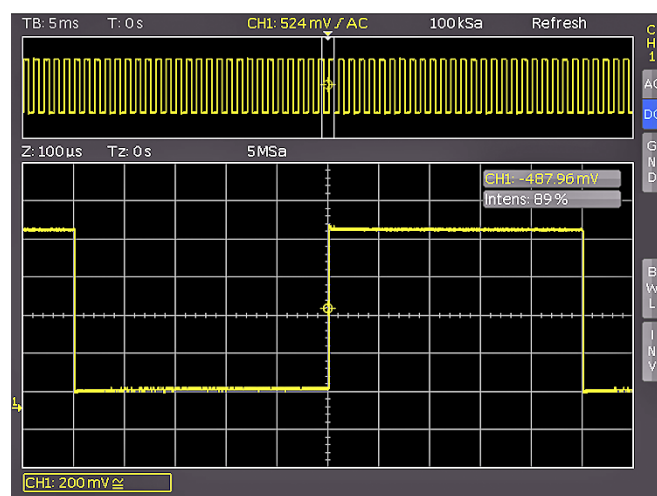

Fig. 5.5: Zoom function

The time base setting in the upper right of the display is highlighted in gray while the zoom time base above the

zoom window is marked in white. The large knob in the HORIZONTAL menu is used to change the zoom factor. You can also press this knob. If the knob is pushed, the time base setting is highlighted in white and the zoom time base in gray. Now the knob is available to select the time base setting. This allows you to change time base settings without having to leave the zoom mode. Pressing the knob again will highlight the cursors limiting the zoom area in white, allowing you to use the knob to change the zoom area. Now you can use the small knob in the horizontal area of the control panel to move the position of the zoomed section across the entire signal. As described above, pressing the large knob enables you to set the time base but not the zoom factor. This in turn enables the small knob to move the trigger position to define the relationship of pre- and post captures/records.

### The ZOOM function is not available in ROLL mode.

In the acquisition mode ROLL, it is generally not possible to zoom in on the memory because the signal values of the X axis are always captured with the maximum memory depth. The acquisition mode NORMAL always includes more samples in the memory than what can be shown in the display. That explains why in this mode you are able to zoom in on the memory. The same does not apply to the values in the Y axis (amplitude). These values apply to a specified axis and can therefore also be scaled in ROLL mode.

## 5.6 Navigation Function

The X-POS. function (MENU key in the HORIZONTAL section) offers easy trigger time handling and allows it to be entered numerically. The soft menu keys allow you to set the trigger time to the minimum or the maximum value, for instance. You can use the soft menu key TIME REFERENCE to define where in the signal window to find the trigger point value "0". The signal is scaled by this reference point. You can use the universal knob in the CURSOR/MENU section to select the desired setting.

## 5.7 Marker Function

Markers allow you to highlight specific positions on the screen, e.g. a rising or falling slope, an unexpected signal value or a search result. Markers can be used to identify specific signal sections to zoom in on and to analyze the data more closely. Use the soft menu to activate the marker function. Press the MENU key in the HORIZONTAL section to open the soft menu. Use the universal knob in the menu to select MARKER. Once this mode is activated, you can press the SET/CLR key to set a time marker at the 6th time unit (the menu in the center of the grid must be deactivated). The time markers are marked by a vertical line in gray-blue. The knob X Position allows you to move the signal including the set marker. After identifying an important signal position and setting it to the center of the screen using the position knob, you can set an additional marker. This procedure allows you to mark up to 8 interesting positions within the signal. You can toggle between markers by pressing the arrow keys ◀▶ [37]. These keys

also allow you to center the markers in the middle of the screen. This feature enables you to quickly compare marked signal sections in ZOOM mode. To delete a marker, center it in the middle of the screen and press the SET/CLR key once again. You can also delete all time markers simultaneously in the marker soft menu. With the soft menu key TRIGGER TIME TO ZERO the trigger time can be set to 0s. Additionally, CLEAR ALL MARKER removes all defined time stamp markers.

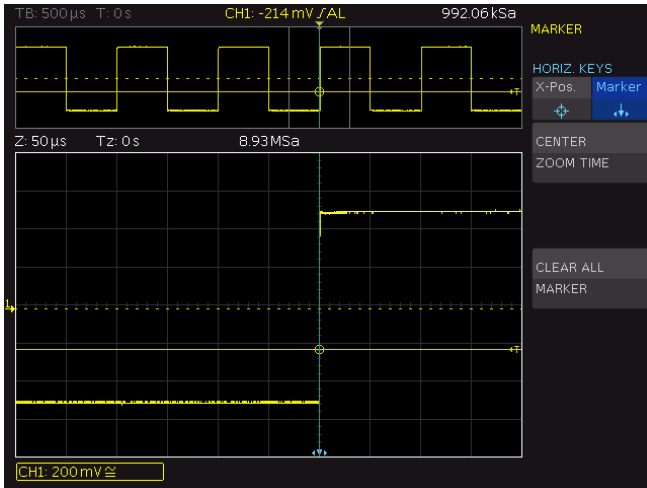

Fig. 5.6: Marker in Zoom mode

# 6 Trigger System

Four keys are available to select one of the frequently used trigger settings:

- **TYPE:** Selection of trigger type Edge, Puls, Logic, Video and Hold off time
- **SLOPE:** Type of slope
- **SOURCE:** Determines the trigger source
- **FILTER:** Determines the exact trigger conditions

Additional keys are available to select the trigger modes (AUTO, NORMAL and SINGLE).

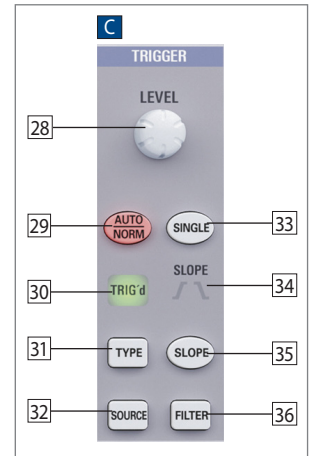

Fig. 6.1: Control panel for the trigger system

## 6.1 Trigger Modes Auto, Normal and Single

The AUTO/NORM [29] key allows you to toggle directly between the basic trigger modes. If Auto mode is activated, the key is not illuminated. Pressing the key will activate NORMAL mode, and a red LED will highlight the key. In AUTO mode, the screen always displays a signal. If a signal fulfills the trigger conditions, the oscilloscope will synchronize with this event and triggers when the set condition is met. In case of a signal that does not fulfill the trigger condition (a simple case would be direct current), the oscilloscope itself will generate a trigger event. This allows a glance at the input signals at any time, regardless of the trigger condition. In NORMAL mode, the signal will now be captured and displayed if the trigger condition is met. In case no new signal fulfills the set trigger condition, the signal that was triggered last will be displayed. To ensure that only a signal that meets the trigger condition is detected and displayed, press the Single key to [33] activate this mode. This key is highlighted in white when the SINGLE mode is activated. The R&S®HMO1002 resp. R&S®HMO1202 series detection and trigger system is now activated, indicated by a blinking RUN/STOP key [39]. If the trigger condition is fulfilled, the trigger system is activated, data is stored and the oscilloscope switches to STOP mode (the RUN/STOP key is permanently highlighted in red).

## 6.2 Trigger Source

The two analog channels are available as trigger sources (SOURCE key). If the optional extension with active logic probes R&S®HO3508 including 8 digital inputs is connected, up to 8 digital inputs are available as trigger source. The soft menu key AC LINE enables you to trigger the trigger at system frequency. The trigger signal is extracted internally from the power supply.

## 6.3 Trigger type

The trigger type can be selected with the TYPE key [17] in the TRIGGER section. A submenu will be opened.

### 6.3.1 Slope Trigger

The easiest and by far the most frequently used trigger is the slope trigger. The oscilloscope triggers if slopes that were set with the EDGE key occur within the signal selected in the SOURCE menu. The signal slope has to pass through the set trigger level. The trigger type EDGE TRIGGER is selected in the Autosetup mode (AUTOSET key). If, for instance, you select the pulse trigger and press the AUTOSET key the setting will switch to Edge Trigger. The TYPE key [31] in the TRIGGER section allows you to set the trigger type. This opens a menu with corresponding options. If the edge type is not active (highlighted in blue), you can press the respective soft menu key to select this type. The slope type (rising, falling or both) can be set directly with the SLOPE [35] key. This will shift the setting forward by one, i.e. from rising to falling slope, to both slopes, and pressing the key yet one more time will trigger another rising slope. The center of the status line on the top of the display and the display above the SLOPE key [35] show which slope type has been selected.

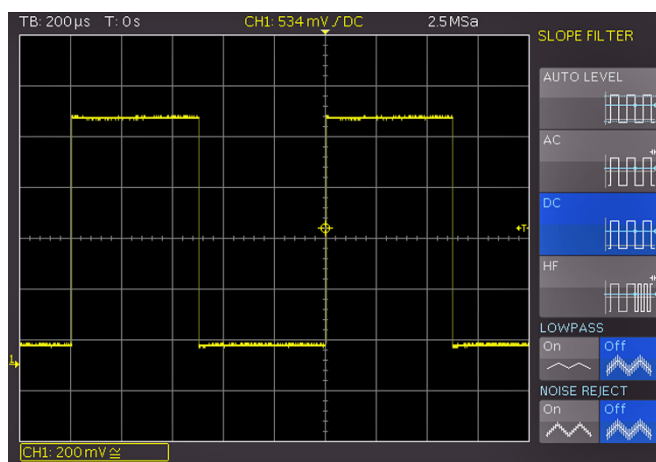

Fig. 6.2: Filter settings of edge trigger

The FILTER [36] key allows you to select how to couple the signal for the trigger circuit:

- **AUTO LEVEL:** Automatic filter setting (default setting).
- **AC:** The trigger signal is coupled via high pass filter with a minimum cut-off frequency of 5 Hz which suppresses the DC portion of the triggering signal. With a changing DC portion, the trigger level remains at the set point in the AC signal. The trigger type AUTO (AUTO/NORM key) includes the Peak-Peak mode which sets limits for the trigger in the AC signal. This setting means that the trigger condition will be met for any applied signal without having to set the level. For the trigger type NORM (AUTO/NORM key), the Peak-Peak mode is deactivated, allowing the trigger level to be moved past the peak values of the signal.
- **DC:** The trigger signal is coupled to the trigger circuit with all signal portions (AC and DC voltage). This has no impact on the triggering signal.
- **HF:** The trigger signal is coupled via high pass filter with a minimum cut-off frequency (-3 dB) of 30 kHz and is automatically limited when triggering the level with normal trigger. This coupling type should only be applied to very high frequency signals.

- **LP (low pass):** The trigger signal is coupled via low pass with a maximum cut-off frequency of 5 kHz. This filter removes high frequencies and is available with AC and DC coupling.
- **NR (noise reduction):** A low pass filter with a maximum cut-off frequency of 100 MHz will improve the noise performance for the trigger amplifier. This filter removes high frequencies and is available with AC and DC coupling.

**The coupling types low pass and noise reduction may not be activated simultaneously.**

### 6.3.2 Pulse Trigger

The pulse trigger allows triggering for specific pulse widths of positive or negative pulses or for pulse width ranges. The oscilloscope triggers if a pulse occurs within the signal selected in the SOURCE menu that matches the properties set in the FILTER menu. If a pulse fulfills the trigger conditions, the oscilloscope triggers on the trailing slope, i.e. for a positive pulse it triggers on the falling slope and for a negative pulse on a rising slope.

Activate the pulse trigger by pressing the TYPE key [31] in the TRIGGER section. Press the FILTER key [36], then you can select additional settings for the pulse trigger in the soft menu. There are six different settings:

- **$t_i > t$ :** The pulse width  $t_i$ , which will generate the trigger is greater than the adjustable reference time  $t$ .
- **$t_i < t$ :** The pulse width  $t_i$ , which will generate the trigger is less than the adjustable reference time  $t$ .
- **$t_i = t$ :** The pulse width  $t_i$ , which will generate the trigger equals the adjustable reference time  $t$ . The reference time is a combination of time  $t$  plus the adjustable deviation.
- **$t_i \neq t$ :** The pulse width  $t_i$ , which will generate the trigger is unequal to the adjustable reference time  $t$ . The reference time is a combination of time  $t$  plus the adjustable deviation.
- **$t_1 < t_i < t_2$ :** The pulse width  $t_i$  which will generate the trigger is less than the adjustable reference time  $t_2$  and greater than the adjustable reference time  $t_1$ .
- **not( $t_1 < t_i < t_2$ ):** The pulse width which will generate the trigger is greater than the adjustable reference time  $t_2$  and less than the adjustable reference time  $t_1$ .

The comparison time can be set between 16 ns to 10 s. For any value up to 1 ms the resolution is 2 ns and for any value greater than 1 ms the resolution is 1  $\mu$ s. The deviation can be set  $\pm 8$  ns up to 657,5  $\mu$ s with a resolution of 8 ns. The time resp. the variation (tolerance zone) can be selected via universal knob or KEYPAD key in the CURSOR/MENU section. Selecting the corresponding soft menu item allows you to set any of these settings for positively (POS.) or negatively polarized pulses (NEG.). For the associated positive pulse, you define the width from rising to falling slopes, and accordingly for the associated negative pulse from falling to rising slopes. As is consistent with the principle, triggering always occurs on the second slope of the pulse.

### 6.3.3 Logic Trigger

You may test all settings in the logic trigger without any active logic probes R&S®HO3508 connected.

Selecting the LOGIC trigger in the soft menu after pressing the TYPE key [31] will switch the trigger source to the digital inputs. Pressing the SOURCE key [32] after selecting this trigger type displays a soft menu for additional settings and a window to list these settings. The soft menu key LOGIC CHANNEL enables you to select a logic channel for which you wish to determine the trigger condition. Use the universal knob in the CURSOR/MENU section for this purpose. In the general menu, the selected digital input is marked with a blue background. In the field, the trigger level is marked as High (H), Low (L) or (X). Use the corresponding soft menu key to select the trigger level. The soft menu item COMBINATION allows the logic combination of the digital channels. They can be combined by logic AND or OR. If AND is selected, the set conditions of all channels must be met simultaneously for the input signal so that the combination produces a logic High (H) as a result. If OR is selected, at least one of the defined level conditions must be met. The last item in this menu is the option TRIGGER ON. Use the soft menu key to select TRUE or FALSE. This allows you to preselect whether the trigger will be generated at the beginning (TRUE) or the end of the logic condition (FALSE).

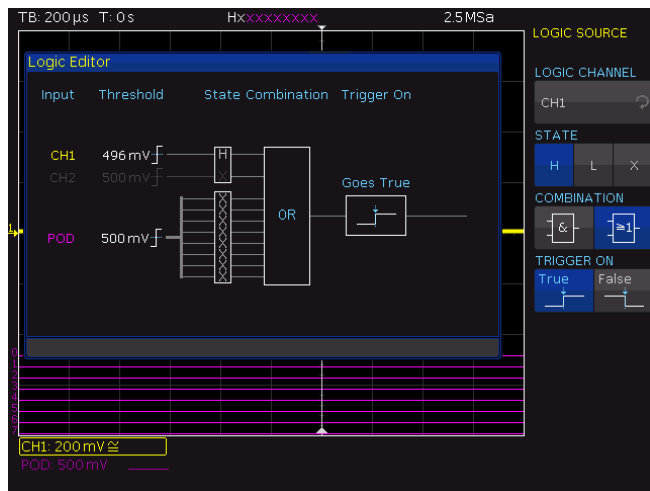

Fig. 6.3: Logic trigger menu

After selecting the desired set of conditions, you can use the FILTER key [36] for additional settings. A soft menu will open allowing you to add a time limit to the TRIGGER ON option (this menu shows the condition selected in the SOURCE menu). Press the top soft menu key DURATION to add a time limit. This option compares the duration of the output signal for the combination of the logic conditions to the set duration  $t_i$ . If the duration is identical or not identical, you can set the deviation  $\Delta t$ . If  $t_i$  is within these parameters, the trigger condition has been met. The menu field below allows the selection of the comparison criteria. The following criteria are available:

- $t_i \neq t$ :** The duration of the applied bit pattern which will generate the trigger is unequal to the adjustable reference time.

- $t_i = t$ :** The duration of the applied bit pattern which will generate the trigger is equal to the adjustable reference time.
- $t_i < t$ :** The duration of the applied bit pattern which will generate the trigger is less than the adjustable reference time
- $t_i > t$ :** The duration of the applied bit pattern which will generate the trigger is greater than the adjustable reference time.
- $t_1 < t_i < t_2$ :** The pulse width  $t_i$  which will generate the trigger is less than the adjustable reference time  $t_2$  and greater than the adjustable reference time  $t_1$ .
- $\text{not}(t_1 < t_i < t_2)$ :** The pulse width which will generate the trigger is greater than the adjustable reference time  $t_2$  and less than the adjustable reference time  $t_1$ .
- Timeout:** Triggers if the combination is still valid after time  $t$ . Time  $t$  defines the trigger time limit for the timeout.

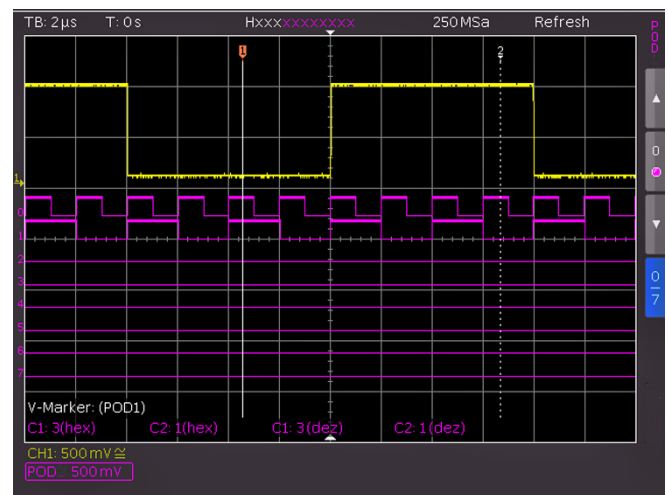

Fig. 6.4: Logic channels' settings display

As with the pulse trigger, for  $t_i \neq t$  or  $t_i = t$  you can set a reference time with the soft menu key TIME and the universal knob. Selecting the soft menu item DEVIATION allows you to use the universal knob and KEYPAD key in the CURSOR/MENU control panel to set the deviation  $\Delta t$  which defines the tolerance between set reference time  $t$  and valid and real pulse width  $t_i$  (permissible tolerance range). To change the threshold values for the logic states "one" and "zero", it is necessary to use settings in the channel menu (MENU key in the VERTICAL section). Select the POD [24]. If logic mode is already activated, the digital channels will be displayed in the channel display section of the display (framed and marked with "POD:xxxV"). Pressing the MENU key [21] in the VERTICAL section allows you to activate one of five predefined logic levels. Three of these are fixed for TTL, CMOS and ECL. After pressing the respective menu item, two customized logic levels may be set from -2V to 8V (USER1 / USER2) with the universal knob or the KEYPAD key in the CURSOR/MENU section. The soft menu key SET TO DEFAULT POS. & SIZE activates the display for all digital channels of the selected group by using default values for the vertical position and size. You may also define the name for the current signal by using the soft menu NAME. A library provides a list of predefined names. The name can be activated, deactivated or edited.



### 6.3.4 Video Trigger

The video trigger allows you to trigger on PAL, NTSC SECAM standard video signals or on HDTV signals. After selecting the VIDEO trigger press the SOURCE  $\boxed{32}$  key. The FILTER  $\boxed{36}$  menu allows you to define additional settings. The oscilloscope triggers if the CVBS signal (Color Video Baseband Signal) selected in the SOURCE menu features the attributes set in the FILTER menu. Select the desired standard by pressing the respective soft menu key STANDARD. Use the universal knob in the CURSOR/MENU section or press the soft menu key again to select the desired standard. The following modes are available:

- ▮ PAL
- ▮ NTSC
- ▮ SECAM
- ▮ PAL-M
- ▮ SDTV 576i Interlaced
- ▮ HDTV 720p Progressive
- ▮ HDTV 1080p Progressive
- ▮ HDTV 1080i Interlaced

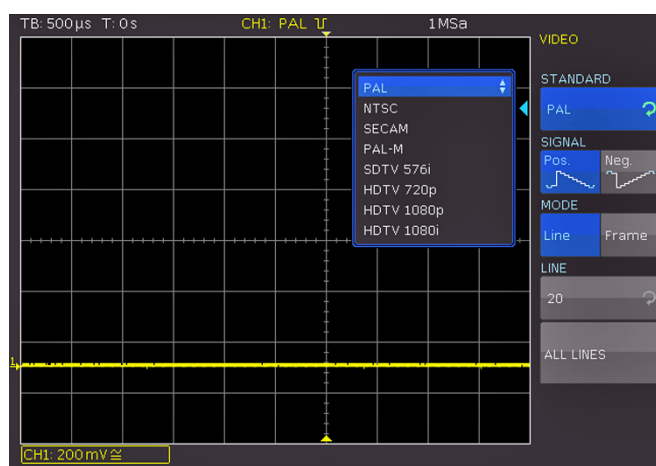

Fig. 6.5: Video trigger menu

The second setting will apply to the polarity of the sync pulse (may be positive or negative). With positive video modulation (the highest brightness is represented in the image by the maximum signal voltage), the synchronization pulses are negative, with negative modulation they are positive. The slopes of the synchronization pulses are used for triggering which explains why a faulty polarity setting causes irregular triggering by image information. Next you can select between frame triggering (FRAME) and line triggering (LINE). Selecting LINE allows you to define the exact line between 1 and 625 via universal knob or the KEYPAD button in the CURSOR/MENU section. The soft menu item ALL LINES enables the oscilloscope to trigger on the start of the lines in the video signal. This key selects all lines i.e. even when other trigger conditions are met, the oscilloscope will trigger on each line. If FRAME is selected for frame triggering, the lower menu items will allow to trigger on ODD or only EVEN half frames. In this case, the oscilloscope will trigger on the start of the half frames in the video signal. The respective key will select the odd (even) half frames, i.e. even if the other trigger conditions are met, the oscilloscope will trigger on each odd (even) half frame.

### 6.3.5 Trigger Hold Off Time

The trigger hold off time indicates how long after a trigger the oscilloscope waits until the trigger system is ready again. The trigger system is active again only after the trigger hold off time has expired. This allows the function to guarantee stable triggering in case unwanted events are triggered. Ideally, the hold off time is used to trigger on periodic signals with several slopes.

**Changing the time base does not impact the selected hold off time.**

HOLD OFF is a dual soft menu key. If the top section of the soft menu key is active (highlighted in blue), a value can be entered in the CURSOR/MENU section via universal knob or numerically via KEYPAD button. You may enter any value between 50ns and 10s. The bottom section of the soft menu key OFF (highlighted in blue) allows you to deactivate the function HOLD OFF.

### 6.4 Trigger Events

Use the UTIL menu in the VERTICAL control panel on page 2|2, and then choose the soft menu key ACQ. TRIGGER EV. to issue a pulse at the AUX OUT connector for each trigger event (Issuing The Trigger Frequency).

### 6.5 External Trigger

The settings for the external trigger input (EXT TRIG IN) can be set via the POD menu. After pressing the POD button you can activate resp. deactivate the external trigger functionality (soft menu key EXT). If the external trigger functionality is activated (ON), the settings for the external trigger functionality can be set via MENU menu in the VERTICAL section of the front panel. Via soft menu key EXT. THRESHOLD the threshold for the external trigger signal can be set. You can use an external trigger signal e.g. for CS (Chip Select) of a SPI BUS (displayed as green line).

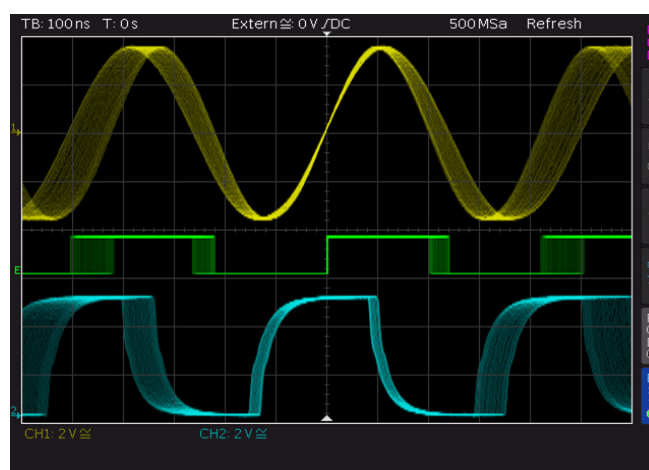

Fig. 6.6: External trigger signal

# 7 Signal Display

The following chapter describes the selection and display of signals from various sources as well as all available display modes.

## 7.1 Display Settings

The R&S®HMO1002 resp. R&S®HMO1202 series features a high quality TFT display with VGA (640x480 pixels resolution) including LED backlighting. Basic display settings can be defined by pressing the DISPLAY **[14]** key in the GENERAL section. When the soft menu item VIRTUAL SCREEN is activated, a scroll bar will display to the right of the display graticule. Use the universal knob to upload and download the display window within the 20 divisions of the virtual screen. You will find a detailed description of the VIRTUAL SCREEN option in the next chapter.

The following settings can be selected:

### ■ DOTS ONLY:

If this option is activated (ON), only the acquired data points will be shown. This means that the data points of all signals will not be connected by vertical lines. If this option is deactivated (OFF), interpolated data points will also be shown.

### ■ INVERSE BRIGHTN..:

This setting inverts the brightness of the displayed signals. Normally, frequently captured dots will be displayed more brightly than rare dots. The INVERSE BRIGHTNESS option reverses the circumstances. Rare events display a higher brightness compared to frequent events. To capture rare events in a signal, this setting can be used in combination with persistence.

### ■ FALSE COLORS:

This setting converts the brightness levels of the displayed signals to a color scale (ranging anywhere from blue, magenta, red and yellow to white). Thanks to the higher contrast, users can view signal details more easily. This setting applies to all signals simultaneously.

### ■ GRID:

This soft menu allows you to display the graticule as LINES (the graticule is divided into horizontal and vertical divisions), as CENTER CROSS (displays one horizontal and one vertical zero line, showing the divisions as dots) or as OFF (the entire graticule will include no dots or lines).

### ■ INFO WINDOWS:

Selecting this soft menu item will open a submenu which allows you to set the transparency for the info windows. Info windows are small windows that appear on the screen depending on the particular application (e.g. values are displayed when offset is changed). A transparency value of 0% to 100% is selectable. Use the universal knob or the KEYPAD key to define this setting. Additional menu items allow you to activate or deactivate the info windows for POSITION and TRACE BRIGHTN.. If POSITION is activated and the vertical position is changed, the respective value on the zero line will be

displayed. Depending on the selected trigger type, the user will see specific information about the acquisition status. This information will only be displayed if the signal changes on the screen can persist over a longer period. If the trigger condition has been met, the information window shows a progress display for the post-trigger and pre-trigger. If the trigger condition has not been met, the information window shows the time of the last trigger event (Trig?). If the trigger type AUTOMATIC is selected, the instrument will switch to non-triggered acquisition mode in case of a non-triggered condition over an extended period of time. This acquisition mode does not display an info window as the data currently captured is displayed.

### ■ AUX. CURSORS:

This soft menu allows you to define the settings for auxiliary cursors. Pressing the function keys enables you to activate or deactivate the cursors. The menu item DEFAULTS resets the default settings.

## 7.2 Usage of the Virtual Screen

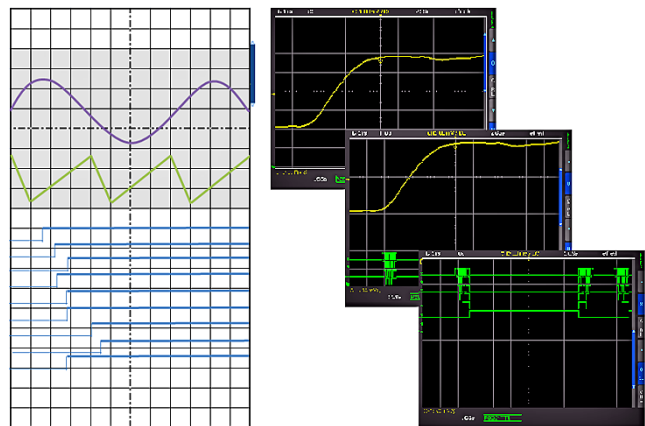

Fig. 7.1: Drawing of the virtual screen area

The graticule for the R&S®HMO1002 resp. R&S®HMO1202 series includes 8 vertical divisions but also has a virtual range of 20 divisions. These 20 divisions may be used entirely by the optional digital channels D0 to D7, the mathematical channels and the references signals. The analog channels may use up to  $\pm 10$  divisions from the center.

Fig. 7.1 illustrates the functionality of the virtual screen. The display includes a section of 8 vertical divisions in gray. This section enables you to display analog signals. The small bar next to the graticule indicates the position of the 8 visible divisions within the available 20 divisions. By pressing the SCROLL BAR **[5]** the bar will be activated and displayed in blue and you can use the universal knob to shift the 8 visible divisions (gray section) within the available 20 divisions. This allows a simple and clear display of many individual signal portions.

### 7.3 Signal Intensity Display and Persistence Function

The default setting (indicated as active when the INTENS/PERSIST  $\boxed{7}$  key is illuminated in white) allows you to use the universal knob to change the intensity of the signal display to anywhere from 0% to 100%. Persistence mode allows the display of varying signals by enabling the instrument to write several signals on the display simultaneously. It is also possible to induce accelerated aging of signals with an adjustable persistence from 50ms to infinite. Signals occurring less frequently will be displayed in darker color and signals occurring more frequently will be displayed in lighter color. Press the INTENS/PERSIST key in the soft menu to select this mode.

The soft menu items TRACE, GRID and BACKLIGHT allow you to use the universal knob in the CURSOR/MENU section to adjust the grid intensity and the backlighting. The soft menu SETTINGS allows you to select the persistence settings for the signals on the screen. The persistence function ensures that signals will not be replaced when the screen is updated. Instead, the signals will pause for a specific amount of time and then slowly begin to fade. This type of display is very similar to that of an analog oscilloscope. There are three possible settings for the duration of the persistence: OFF, AUTOMATIC and MANUAL.

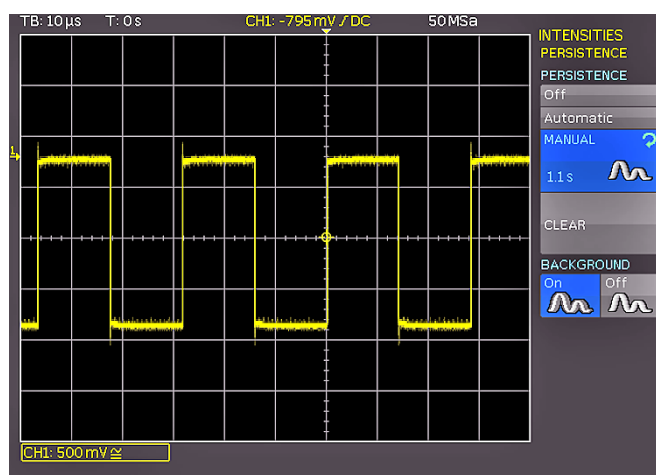

Fig. 7.2: Persistence function

The option MANUAL allows you to set a duration of 50ms to infinite by using the universal knob or the KEYPAD key. If a finite duration was selected, new signals will be written on top of one another within this timeframe where the most recent captures will be displayed more brightly than older signals. For instance, if 300ms is selected, the display for the signal curves will become darker in 50ms intervals and will be erased after 300ms. The AUTOMATIC setting allows you to select the automatic configuration of the persistence. If this setting is activated, the instrument attempts to select the optimal time. If OFF is selected, the persistence function is deactivated.

Another available option is the BACKGROUND function. With this key, you can activate or deactivate a mode which allows older signal curves to not disappear entirely after

the set persistence time. Instead, these signals will continue to be displayed in the background with low brightness. This display is useful for the analysis of peak values in signals, for instance.

### 7.4 XY display

The R&S®HMO1002 resp. R&S®HMO1202 series features a key that allows you to switch directly to the XY display. Two signals will be displayed simultaneously, one in Y direction and one in X direction. This implicates that the time base X will be replaced by amplitude values of a secondsource. The resulting signal curves for harmonic signals are known as Lissajous figures and allow the analysis of frequency and phase position for these two signals. In case of a nearly identical frequency the figure will rotate. If the frequency is exactly identical, the figure will stand still and the phase position can be deduced from its shape.

You can activate the XY display by pressing the UTIL key  $\boxed{19}$  in the VERTICAL section. The display will be divided into one large and three small display areas. The large grid shows the XY display while the small grids show the source for X and Y. The small windows feature the classical signal display as Y vs. time. The analog channels can be selected as source.

# 8 Measurements

There are two different types of measurements on signals: cursor measurements and automatic measurements. All measurements are stored in a buffer memory that is larger than the display memory. The integrated hardware counter shows the frequency and period duration for the selected input.

## 8.1 Cursor Measurements

The measurement option that is most frequently used with an oscilloscope is the cursor measurement. Depending on the measurement type up to three markers are available. To control cursor measurements, you may use the keys CURSOR MEASURE and KEYPAD as well as the universal knob. The menu CURSOR MEASURE allows you to select cursor-based measurements for an activated signal source on the oscilloscope. The measurement type can be defined in the menu that opens when you press the CURSOR MEASURE key.

Following measurement types can be selected:



**VOLTAGE:** This mode provides two cursors to measure three different voltages. The values V1 and V2 correspond to the voltage between the zero base line of the selected signal and the current position of the first or second cursor. The value  $\Delta V$  corresponds to the amount of voltage between the two cursors.



**TIME:** This mode provides two cursors to measure three different times and an equivalent frequency. The values t1 and t2 correspond to the time between the trigger and the current position of the first or second cursor. The value  $\Delta t$  corresponds to the amount of time between the two cursors.



**RATIO X:** This mode provides three cursors to measure a ratio in X direction (e.g. a duty ratio) between the first two cursors and the first and the third cursor. The measurement values are displayed in four different formats (floating point, percent, degrees and radians).



**RATIO Y:** This mode provides three cursors to measure a ratio in Y direction (e.g. an overshoot) between the first two cursors and the first and the third cursor. The measurement values are displayed in two different formats (floating point and percent).



**COUNT:** This mode provides three cursors to count signal changes that exceed the threshold within a specific interval. The interval may be set by using the first two cursors and the threshold may be set by using the third cursor. The measurement values are displayed in four different formats (number of rising and falling slopes and number of positive and negative pulses).



**PEAK VALUES:** This mode provides two cursors to measure the minimum and the maximum voltage of a signal within the interval set by using both cursors. The values Vp- and Vp+ correspond to the minimum and the maximum voltage. The peak value (Vpp) corresponds to the amount of voltage between the minimum and maximum value.



**RMS, MEAN, STANDARD DEVIATION:** This mode provides two cursors to measure the effective value (RMS – Root Mean Square), the mean value and the standard deviation within the interval set by using both cursors.



**DUTY RATIO:** This mode provides three cursors to determine the duty ratio between the two horizontal cursors. The third cursor is used to specify the threshold at which the duty ratio is measured.



**BURST WIDTH:** This mode determines the duration of burst from the first edge to the last edge (Bst).



**RISE TIME 90%:** This mode provides two cursors to measure the rise and fall time of the first rising slope in the displayed view of the screen within the time span set by the cursors. The rise time identifies the time in which the signal rises from 10% to 90% of its amplitude.



**RISE TIME 80%:** This mode provides two cursors to measure the rise and fall time of the first rising slope in the displayed view of the screen within the time span set by the cursors. The rise time identifies the time in which the signal rises from 20% to 80% of its amplitude.



**V-MARKER:** This mode provides two cursors to measure three different voltages and a time. The values V1 and V2 correspond to the voltage between the zero base line of the selected curve and the current position of the first or second cursor. The value  $\Delta V$  corresponds to the amount of voltage between the two cursors. The value  $\Delta t$  corresponds to the amount of time between the two cursors.

**CREST FACTOR:** The crest factor (peak-to-average ratio) is calculated from the maximum value divided by the RMS value of the waveform (Crest).

To move cursors, press the universal knob in the CURSOR/MENU section and position the cursor by turning the universal knob. The measurement types have the following functions. The measurement results are displayed at the bottom of the screen. If “n/a” is displayed, the measurement is not applicable to the signal. For instance, this may be the case for a voltage measurement on a POD because only logic sta-

tes without voltage reference are displayed here. If “?” is displayed, the display does not show a complete measurement result. For instance, the period to be measured may not display completely and can consequently not be identified.

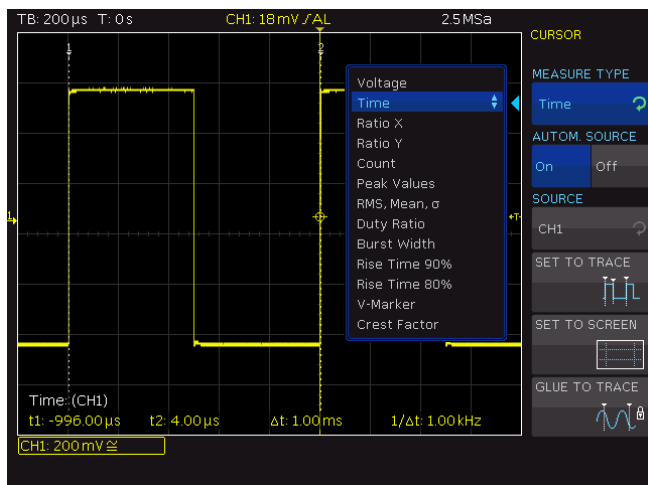

Fig. 8.1: Cursor measurement setting menu

If the function AUTOM. SOURCE is activated (ON), the currently targeted channel will be used as source for the measurement automatically. If the setting is deactivated (OFF), the channel set under SOURCE will be applied even if it is not targeted. Pressing the soft menu key SET TO TRACE places the selected cursors in their optimal position on the signal curve. This allows very fast and typically optimal automatic positioning of the cursors. For the most part, only fine tuning is required at this point and the tedious major adjustments to the cursors will no longer be necessary. In case the automated function SET TO TRACE does not provide the anticipated results due to complex signals, you can press the key SET TO TRACE to position the cursors in a predefined starting position. This allows you to return distant cursors to the screen. The soft menu key GLUE TO TRACE allows cursors to stay on the selected data point without changing the position in the measurement signal even if the scaling is modified (cursors will be „glued“ to the signal). This function can be activated or deactivated. If this mode is deactivated, the cursor stays in position on the screen if scaling occurs. With GLUE TO TRACE deactivated, the measured value changes while it remains unmodified when the mode is activated.

The cursors will be deactivated by pressing the CURSOR MEASURE key. The cursor menu will be closed.

## 8.2 Automatic Measurements

The R&S®HMO1002 resp. R&S®HMO1202 series features cursor measurements and also various automatic measurements. These may be activated by pressing the key AUTO MEASURE (M) in the section ANALYZE. This menu allows you to select up to six automatic measurement functions by using the soft menu key MEAS. PLACE and the universal knob in the CURSOR/MENU section. Following automatic measurement types can be selected:



**MEAN VALUE:** This mode measures the mean value of the signal amplitude (Mean). If the signal is periodic, the first period on the left of the screen will be used for the measurement. The measurement will only be applied to the selected channel.



**RMS VALUE:** This mode identifies the effective value from the displayed view of the signal. If the signal is periodic, the first period on the left of the screen will be used for the measurement. The effective value is not applied to a sine signal will be calculated directly (so-called TrueRMS). The measurement will only be applied to the selected channel.



**PEAK-PEAK:** This mode measures the difference in voltage between the maximum and the minimum peak value of the signal within the displayed view ( $V_{pp}$ ).



**PEAK + :** This mode measures the maximum voltage value in the displayed view of the screen. The measurement will only be applied to the selected channel ( $V_{p+}$ ).



**PEAK - :** This mode measures the minimum voltage value in the displayed view of the screen. The measurement will only be applied to the selected channel ( $V_{p-}$ ).



**FREQUENCY:** This mode identifies the frequency of the signal from the reciprocal value of the first signal period  $T$  ( $f$ ). The measurement will only be applied to the selected channel.



**PERIOD:** This mode measures the duration of the signal period  $T$ . The period identifies the duration between two equal values of one periodically repeated signal.



**AMPLITUDE:** This mode measures the amplitude of a square wave signal ( $V_{Amp}$ ). This mode calculates the difference in voltage between the upper and the lower level ( $V_{base}$  and  $V_{top}$ ). The measurement will only be applied to the selected channel and requires a minimum of one complete period of a triggered signal.

**CREST FACTOR:** The crest factor (peak-to-average ratio) is calculated from the maximum value divided by the RMS value of the waveform (Crest).



**TOP LEVEL:** This mode measures the mean voltage level of an upper square wave ( $V_{Top}$ ). This mode calculates the mean value of the slope (without overshoot). The measurement will only be applied to the selected channel and requires a minimum of one complete period of a triggered signal.

## Measurements



**BASE LEVEL:** This mode measures the mean voltage level of the lower square wave ( $V_{Base}$ ). This mode calculates the mean value of the slope (without overshoot). The measurement will only be applied to the selected channel and requires a minimum of one complete period of a triggered signal.



**POS. OVERSHOOT:** This mode measures the positive overshoot of a square wave which is calculated from top level, peak + and amplitude value (+Ovr).



**NEG. OVERSHOOT:** This mode measures the negative overshoot of a square wave which is calculated from base level, peak - and amplitude value (-Ovr).



**PULSE WIDTH +:** This mode measures the width of the positive pulse. A positive pulse consists of a rising slope followed by a falling slope. This measurement type identifies the two slopes and calculates the pulse width from their time difference. The measurement will only be applied to the selected channel and requires a minimum of one completely displayed period of a triggered signal.



**PULSE WIDTH -:** This mode measures the width of the negative pulse. A negative pulse consists of a falling slope followed by a rising slope. This measurement type identifies the two slopes and calculates the pulse width from their time difference (t). The measurement will only be applied to the selected channel and requires a minimum of one completely displayed period of a triggered signal.



**DUTY CYCLE +:** This mode measures the positive duty ratio. In this mode, positive signal portions are identified over a specific period and will then be analyzed in relation to the signal period. The measurement will only be applied to the selected channel and requires a minimum of one complete period of a triggered signal. The measured value Dty+ is displayed as a percentage of the signal period.



**DUTY CYCLE -:** This mode measures the negative duty ratio. In this mode, positive negative portions are identified over a specific period and will then be analyzed in relation to the signal period. The measurement will only be applied to the selected channel and requires a minimum of one complete period of a triggered signal. The measured value Dty+ is displayed as a percentage of the signal period.



**RISE TIME 90%:** This mode measures the rise time of the first rising slope in the displayed view of the screen ( $t_r$ ). The rise time identifies the time in which the signal rises from 10% to 90% of its amplitude.



**FALL TIME 90%:** This mode measures the fall time of the first falling slope in the displayed view of the screen ( $t_f$ ). The fall time identifies the time in which the signal falls from 90% to 10% of its amplitude.



**RISE TIME 80%:** This mode measures the rise time of the first rising slope in the displayed view of the screen ( $t_{r80}$ ). The rise time identifies the time in which the signal rises from 20% to 80% of its amplitude.



**FALL TIME 80%:** This mode measures the fall time of the first falling slope in the displayed view of the screen ( $t_{f80}$ ). The fall time identifies the time in which the signal falls from 80% to 20% of its amplitude.



**$\sigma$ -STD. DEVIATION:** This mode measures the standard deviation of the signal amplitude in the displayed view of the screen. The standard deviation is the measurement for the deviation of a signal from its mean value. A low result indicates that the values are close to the mean value. A higher result illustrates that on average the difference between the values is greater.



**DELAY:** This mode measures the time delay between the set measurement source and the reference source. This mode searches for the slope of the measurement source that is closest to the time reference. Then, beginning from this point, it searches for the nearest slope of the reference source. This time difference indicates the measurement result. A submenu (DELAY SETUP) allows you to select the setting for measurement source, reference source and slopes.



**PHASE:** This mode measures the phase between two slopes of two channels in the displaced view of the screen (Phs). This mode measures the relation of the time delay between the set sources to the signal period of the measurement source. This mode searches for the slope of the measurement source that is closest to the time reference. Then, beginning from this point, it searches for the nearest slope of the reference source. The time difference and the signal period indicate the measurement result in degrees. A submenu (MEASUREMENT SOURCE/ REFERENCE SOURCE) allows you to select the measurement source and the reference source with the universal knob in the CURSOR/MENU section.



**BURST WIDTH:** This mode determines the duration of burst from the first edge to the last edge (Bst).



**COUNT +:** This mode counts positive pulses in the displayed view of the screen. A positive pulse consists of a rising slope followed by a

falling slope. The mean value is calculated from the amplitude of the measurement signal. A slope will be counted if the signal runs through the mean value. A pulse that passes the mean value only once will not be calculated. The measurement will only be applied to the selected channel.



**COUNT - :** This mode counts negative pulses in the displayed view of the screen. A negative pulse consists of a falling slope followed by a rising slope. The mean value is calculated from the amplitude of the measurement signal. A slope will be counted if the signal runs through the mean value. A pulse that passes the mean value only once will not be calculated. The measurement will only be applied to the selected channel.



**COUNT +/- :** This mode counts signal changes (slopes) from Low Level to High Level in the displayed view of the screen. The mean value is calculated from the amplitude of the measurement signal. A slope will be counted if the signal runs through the mean value. The measurement will only be applied to the selected channel.



**COUNT -/ :** This mode counts signal changes (slopes) from High Level to Low Level in the displayed view of the screen. The mean value is calculated from the amplitude of the measurement signal. A slope will be counted if the signal runs through the mean value. The measurement will only be applied to the selected channel.



**TRIGGER FREQUENCY:** This mode measures the frequency of the trigger signal bases on the period duration ( $f_{Tr}$ ). The source for the measurement is the currently set trigger source. The frequency will be determined with a hardware counter with a high accuracy of 5 digits.



**TRIGGER PERIOD:** This mode measures the duration of periods of the trigger signal (with a hardware counter  $T_{Tr}$ ).

The automatic measurement results are displayed at the bottom of the screen. If "n/a" is displayed, the measurement is not applicable to the signal. For instance, this may be the case for a voltage measurement on a POD because only logic states without voltage reference are displayed here. If "?" is displayed, the display does not show a complete measurement result. For instance, the period to be measured may not display completely and can consequently not be identified.

**The list of available sources only includes displayed channels (possible sources are analog, digital and mathematical channels).**

With the soft menu key CLEAR ALL the activated automatic measurements will be switched off.

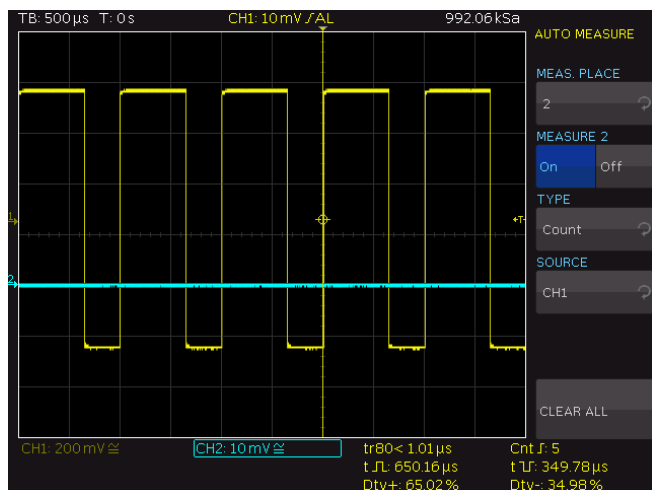

Fig. 8.2: Auto measurement setting menu

# 9 Analysis

The R&S®HMO1002 resp. R&S®HMO1202 series features different analysis functions for the collected data records which are displayed on the screen. Simple mathematical functions can be performed with the mathematical function while more complex functions and the linking of functions can be accomplished with the formula editor (only with R&S®HMO1202 series). The MATH menu includes mathematical functions for the recorded signal types. The mathematical functions track the changes of the included signals and only apply to the visible area. You can also activate the frequency analysis (FFT) by pressing the respective key. The function QUICK VIEW provides a quick overview for the signal properties. A masked-based PASS/FAIL test allows you to monitor signals automatically.

## 9.1 Mathematical Functions

The MATH menu in the VERTICAL section includes mathematical functions for the recorded signal types. The mathematical functions track the changes of the included signals and only apply to the visible area of the screen. If a signal is cut off at the edge of the screen may indicate that the corresponding mathematical curve is also truncated. The VOLTS/DIV knob can be used to scale an activated mathematical curve.

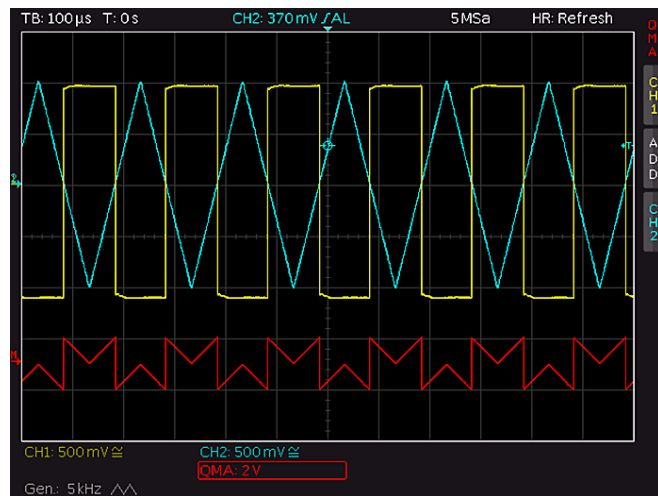

Fig. 9.1: Example of a mathematical waveform

The MATH menu includes the Quick Mathematics (QM) and formula sets (MA). Quick Mathematics is designed for simple and quick calculations. The formula sets allow formular combinations.

**The R&S®HMO1002 series only supports the Quick Mathematics functionality (QM).**

### 9.1.1 Quick Mathematics (QM)

Pressing the MATH key in the VERTICAL section will activate the math short menu. The lowest soft menu key activates the Quick Mathematics (QM) or the formula editor (MA). In the QM short menu the configuration of the math function can be selected with the soft menu key. Pressing

the MENU key in the VERTICAL section the configuration menu will be opened. With the first and the third soft menu key OPERAND, you can choose the respective channel (source) for the mathematical calculation. You may only choose activated analog channels. The central soft menu key OPERATOR allows you to select the calculation type. Following calculation types (OPERATOR) can be selected:

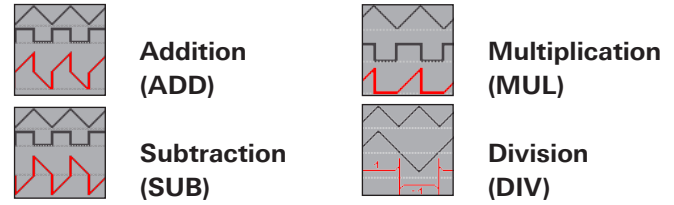

You can use the universal knob in the CURSOR/ MENU section to select operands and operators.

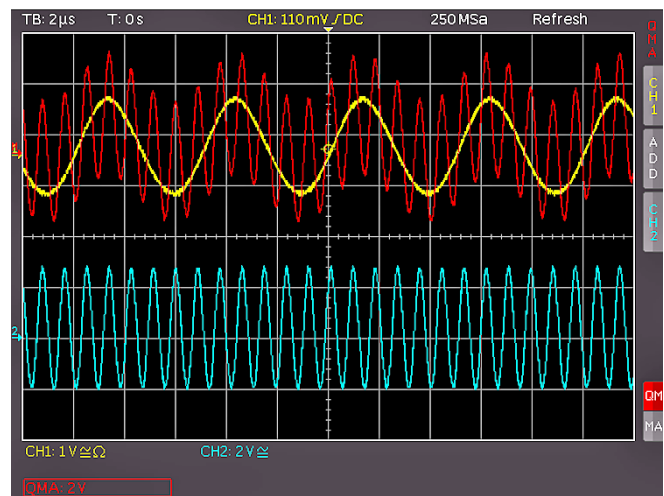

Fig. 9.2: Quick Mathematics menu

### 9.1.2 Formula Editor (MA)

The formula editor menu of the R&S®HMO1202 series (soft menu key MA) allows you to activate and deactivate mathematical equations which are defined and displayed within the selected formula set. The MENU key in the VERTICAL control panel opens a menu to select the formula set and its corresponding formulas. The R&S®HMO Compact series includes five mathematical formula sets. Each of these formula sets contains five formulas which may be edited with a formula editor to also define linked mathematical functions. These are labeled MA1 to MA5. You can use the universal knob in the CURSOR/MENU section to select the formula set. The formula set editor (soft menu key EDIT FORMULARY) lists all existing equations which may be edited. A blue bar indicates that an equation is selected. It is important to distinguish between editing the display and editing the parameters. Use the universal knob in the CURSOR/MENU section to select the respective equation and activate by pressing the soft menu key VISIBLE. An activated, visible equation is marked by a filled-in eye symbol in the formula editor and is listed in the short menu. With the soft menu UNIT you can use the universal knob in the CURSOR/MENU section to select the following units:



- ▮ V (Volt)
- ▮ A (Ampere)
- ▮ Ω (Ohm)
- ▮ V/A (Volt per Ampere)
- ▮ W (Watt)
- ▮ VA (Volt Ampere)
- ▮ VAR (reactive power)
- ▮ dB (decibel)
- ▮ m (Milli, 10<sup>-3</sup>)
- ▮ μ (Mikro, 10<sup>-6</sup>)
- ▮ n (Nano, 10<sup>-9</sup>)
- ▮ p (Piko, 10<sup>-12</sup>)
- ▮ f (Femto, 10<sup>-15</sup>)
- ▮ a (Atto, 10<sup>-18</sup>)
- ▮ z (Zepto, 10<sup>-21</sup>)
- ▮ y (Yokto, 10<sup>-24</sup>)
- ▮ K (Kilo, 10<sup>3</sup>)
- ▮ M (Mega, 10<sup>6</sup>)
- ▮ G (Giga, 10<sup>9</sup>)
- ▮ T (Tera, 10<sup>12</sup>)
- ▮ P (Peta, 10<sup>15</sup>)
- ▮ E (Exa, 10<sup>18</sup>)
- ▮ Z (Zetta, 10<sup>21</sup>)
- ▮ Y (Yotta, 10<sup>24</sup>)
- ▮ dBm (decibel milliwatt)
- ▮ dBV (decibel Volt)
- ▮ s (second)
- ▮ Hz (Hertz)
- ▮ F (Farad)
- ▮ H (Henry)
- ▮ % (percent)
- ▮ ° (degree)
- ▮ π (Pi)
- ▮ Pa (Pascal)
- ▮ m (meter)
- ▮ g (Acceleration)
- ▮ °C (Degress Celsius)
- ▮ K (Kelvin)
- ▮ °F (Degrees Fahrenheit)
- ▮ N (Newton)
- ▮ J (Joule)
- ▮ C (Coulomb)
- ▮ Wb (Weber)
- ▮ T (Tesla)
- ▮ (dez) (decimal)
- ▮ (bin) (binary)
- ▮ (hex) (hexadecimal)
- ▮ (oct) (octal)
- ▮ DIV (Division, division)
- ▮ px (pixel)
- ▮ Bit (Bit)
- ▮ Bd (Baud)
- ▮ Sa (Sample)

- ▮ Square
- ▮ Root
- ▮ Amount
- ▮ Pos. Wave
- ▮ Integral
- ▮ IIR Low Pass Filter
- ▮ IIR High Pass Filter

For each corresponding equation, the input channels CH1, CH2, CH3, CH4 and an adjustable constant are allowed as OPERAND (sources). For the formula MA2, MA1 is added as source, for MA3 the added source is MA2, for MA4 it is MA3 and finally for MA5 the added source is MA4. From these five equations, you can create, save and retrieve a total of five different sets. New equations can be added by using the universal knob to select the menu item NEW in the formula set editor. Pressing the soft menu key ADD allows you to edit the new equation.

Use the soft menu key EDIT CONSTANT and the universal knob in the CURSOR/MENU section to choose from the following constants:

- ▮ Pi
- ▮ 2x Pi
- ▮ 0,5 x Pi
- ▮ User 1 to 10 (up to 10 customized constants are available)

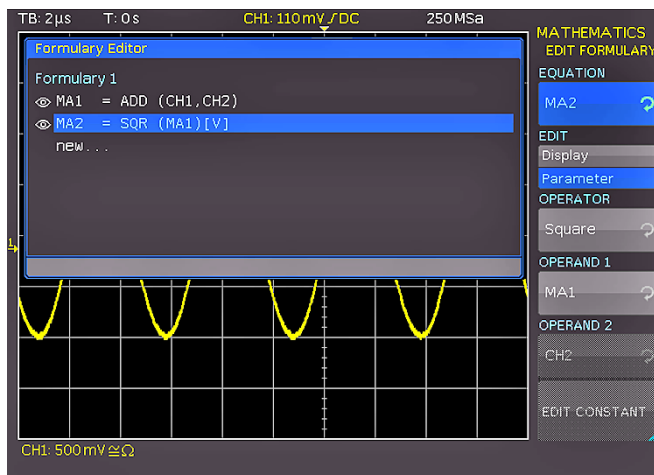

Fig. 9.3: Formula editor for formula sets

The selected equation unit will be applied to the channel description, cursor types and automatic measurement types. The equation name is listed in the formula set editor and is used as label in the curve window. The soft menu key DELETE removes the equation from the formula set. An equation consists of an operator (mathematical function) and up to two operands. Use the universal knob in the CURSOR/MENU section to choose the operators:

- ▮ Addition
- ▮ Subtraction
- ▮ Multiplication
- ▮ Division
- ▮ Maximum
- ▮ Minimum
- ▮ Neg. Wave
- ▮ Reciprocal
- ▮ Inverted
- ▮ Common logarithm
- ▮ Natural logarithm
- ▮ Derivation



Fig. 9.4: Entry of constants and units

For instance, if you select USER1 as constant, you can press the soft menu key VALUE and use the universal knob in the CURSOR/MENU section to select a numeric value. You can apply the same method to set a DECIMAL POINT and enter an additional SI prefix (soft menu key PREFIX). You may choose a UNIT from the same SI prefixes as those that are available in the soft menu EDIT. Press SAVE to store these settings as USER 1 and return to the menu to edit the equation. You can store up to 10 of these customized constants. When saving a formula set, you may also add a comment (soft menu key COMMENT). Press the key SAVE to save this formula set with the determined name and comment to the selected location. Stored formula sets may be reloaded at any time. Press the MATH key to activate the Mathematics menu and then press the MENU key below the VOLTS/DIV key. This menu displays the menu item LOAD. This will start the file manager which will display the internal memory or the connected USB stick as possible storage location. Select the respective formula set

file and press the key LOAD to load the file. It will be calculated, but will not be included in the display. You can also choose a NAME with a maximum of 8 characters, load a formula set (from the internal memory or from a USB stick) or save a formula set (internally or on a USB stick). You can use the universal knob to enter the name of your choice and you can save it by using the ACCEPT key. The name will now be displayed instead of the generic labels MA1 to MA5. You can specify the names for all equations separately. Once all equations, constants and names have been entered, you may also choose a name for this formula set by pressing the NAME key in the formula set menu and entering the name of your choice.

### 9.1.3 Example for using the extended math (R&S®HMO1202 series)

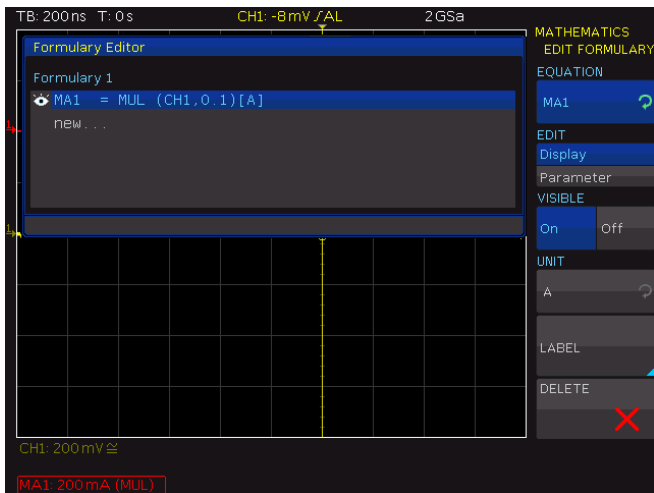

Fig. 9.5: Definition of the current equation

This example shows the analysis of an electrical energy waveform. The voltage across the load is being measured with differential probe and applied to channel 2. The current is being measured with a current probe and applied to channel 1. First, the conversion factor of the current probe (100 mV/A) will be entered. The formula set 1 will be opened and the equation MA1 will be defined. After pushing the soft menu key EDIT, the appropriate functions can be selected using the universal knob in the CURSOR/MENU section. In this example, channel CH1 will be multiplied with a constant (0.1) and the unit A (Ampere) will be assigned. This ensures the correct display of the scale factors as well as the units for cursors and automatic measurements. The equation MA1 can be named „CURRENT using the soft menu key LABEL.

Afterwards, a new equation MA2 will be entered and adjusted. The result of the equation calculation „CURRENT“ and channel CH2 will be multiplied which will be yielded to a power curve. The equation MA2 can be named „POWER“ using the soft menu key LABEL. At last, a 3rd equation MA3 will be added to the set of formulas which will be defined as the integral of the equation „POWER“. The equation MA3 can be named „ENERGY“ using the soft menu key LABEL.

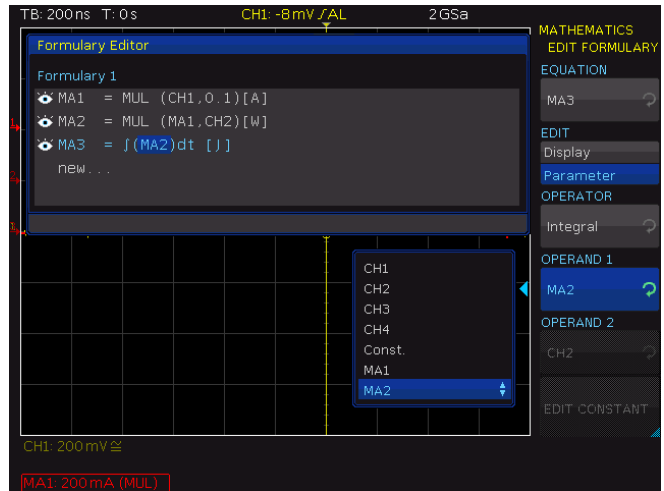

Fig. 9.6: Definition of the power equation

Now, all definitions will be completed and the results can be displayed and analysed. The math analysis can be performed with cursor or automatic measurement functions. All measurement results will be correctly shown and scaled with correct units: Ampere, Watt, Joule.

## 9.2 Frequency Analysis (FFT)

In general, the FFT in an oscilloscope works differently than in a spectrum analyzer and is affected not only by the time base setting, but also by the available number of used acquired data points when calculating the FFT. The R&S®HMO1002 allows you to include up to 128k point in the FFT.

**The FFT is not suitable for the analysis of very slow signals (Hz-range); this type of analysis requires a classic oscilloscope mode.**

The FFT menu in the ANALYZE section allows a quick Fourier transformation which displays the frequency spectrum of the measured signal. The changed display allows you to determine the most frequent frequencies in the signal and the corresponding amplitude. Once the FFT key was pressed, the screen will be divided into two graticules. The upper left of the display shows information about the settings in the time range, the area between the upper and the lower window shows details about zoom and position, and the section below the large FFT display window indicates the settings (Span and Center) in the frequency range. The lower FFT display window will be outlined in white when the FFT is activated. This means that the large knob in the time range section is used to select the span. The span is specified in the unit Hz (Hertz) and identifies the width of the shown frequency range. The span position can be determined by selecting the center value. You may use the horizontal encoder X Position for this purpose. The shown frequency range ranges from (Center - Span/2) to (Center + Span/2).

**The minimum increment depends on the time base. The greater the time base, the smaller the span. Another important element for the FFT is the setting “Max. Sampling Rate” in the ACQUIRE menu.**

The soft menu key MODE allows you to choose from the following display types:

**REFRESH:**

This mode calculates and displays the FFT without additional evaluation or editing of the captured data. The new input data is captured, displayed and overwrites previously stored and displayed values.

**ENVELOPE:**

In the Envelope mode, the maximum deflections of all spectra will be stored separately in addition to the current spectrum and will be updated with each new spectrum. These maximum values will be displayed with the input data and create an envelope curve. The spectrum is located within the envelope limits. This forms an area or a sleeve including all occurrences of FFT signal values. With each signal parameter change the envelope curve will be reset.

**AVERAGE:**

This mode calculates the mean value from several spectra. It is applicable for noise reduction. The soft menu key #AVERAGES allows you to select the number of spectra used to calculate the mean value by setting the universal knob in the power of 2 from 2 to 512.

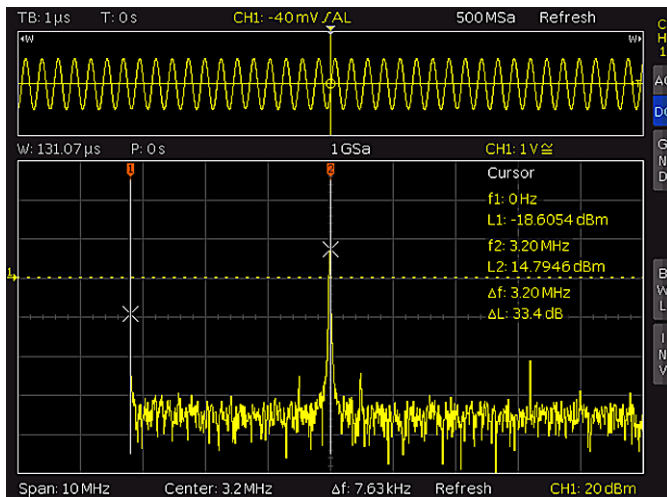
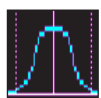

Fig. 9.7: FFT

The menu entry POINTS allows you to select the maximum number of capture points to be included in the calculation by using the universal knob in the CURSOR/MENU section. The possible settings are 2048, 4096, 8192, 16384, 32768, 65536, 131072 points. The soft menu WINDOWS allows you to improve the FFT display in case of irregularities at the margins of the measurement interval. Irregularities are calculated as a leap by a computing algorithm and interfere with the measurement result. In the event of a bell-shaped window function, the margins with lower values are multiplied and the impact is damped. The soft menu item WINDOW allows you to choose from the following window functions:



**HANNING:** The Hanning window function is bell-shaped. In contrast to the Hamming window function, it is equal to zero at the margin of the measurement interval. Therefore the noise level is reduced in the spectrum and the width of the spectral lines

is increased. This function is useful for a precise amplitude measurement of a period signal, for instance.



**HAMMING:** The Hamming window function is bell-shaped. In contrast to the Hanning and Blackman window function, it is not equal to zero at the margin of the measurement interval. Therefore the height of the noise level in the spectrum is greater than with the Hanning and Blackman window function but less than with the square wave window function. However, the spectral lines not as wide as in other bell-shaped functions. This function is useful for a precise amplitude measurement of a period signal, for instance.



**BLACKMAN:** The Blackman window function is bell-shaped and its waveform features the steepest fall-off among the available functions. It is zero at both ends of the measurement interval. The Blackman window function allows you to measure the amplitudes with high accuracy. However, it is more difficult to determine the frequency due to the wide spectral lines. This function is useful for a precise amplitude measurement of a period signal, for instance.



**RECTANGLE:** The rectangle function multiplies all points by 1. This results in a high frequency accuracy with narrow spectral lines and increased noise. This function can be used for pulse response tests with start and end values of zero.

The menu item Y-SCALING allows you to scale the FFT in the amplitude logarithmically (dBm / dBV) or linear ( $V_{eff}$ ). The unit dBm (Decibel-Milliwatt) refers to 1 mW. The unit dBV (Decibel-Volt) refers to 1 V<sub>eff</sub>. The displayed values refer to a 50 Ohm terminating resistor. You can use an external terminating resistor parallel to the high impedance input.

You can deactivate the FFT function by pressing the soft menu key FFT OFF or pressing the FFT key on the control panel again.

**9.3 Quick View**

Pressing the QUICKVIEW key  $\square$  in the ANALYZE section activates several basic automatic measurements. The QUICK VIEW function allows a quick overview of the typical signal size. Measurement results are displayed at the bottom of the screen and with a cursor on the signal.

The following five measurement values are displayed directly in the signal:

- Maximum voltage ( $V_{p+}$ )
- Mean voltage (Mean)
- Minimum voltage ( $V_{p-}$ )
- Rise time ( $t_r$ )
- Fall time ( $t_f$ )

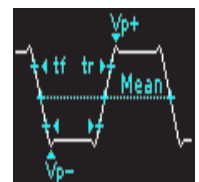

## Analysis

The following ten measurement values are displayed at the bottom of the screen:

- RMS value
- Peak to peak voltage
- Amplitude
- Pos. pulse width
- Pos. duty ratio
- Period
- Frequency
- Number of positive /slopes
- Neg. pulse width
- Neg. duty ratio

Pressing the AUTO MEASURE key allows you to change the six measurement parameters on the bottom right. You may undo these changes by choosing RESET or restore the default setting. Only one channel can be active in the Quickview mode. All measurements will be performed on the active channel.

Pressing the QUICK VIEW key again switched off the function.

### 9.4 PASS/FAIL Test based on Masks

The Pass/Fail test allows you to evaluate if a signal is located within defined limits. This limits are set by a so-called mask. If the signal exceeds the mask, there is an error. These errors will be displayed together with successful sweeps and the total of all sweeps at the bottom of the screen. It is also possible to perform certain actions if errors are discovered.

Press the UTIL key in the VERTICAL section and press the soft menu key PASS/FAIL on page 2|2 to activate the mode which opens a menu to set and use the mask test. Prior to starting the test by pressing the top soft menu key TEST ON/OFF, it is necessary to generate or load a mask and to select an action. To generate a new mask, press the soft menu key NEW MASK. Masks are displayed as light gray curves/waveforms on the screen. If a mask was copied or loaded, you can use menu items to change the expansion of the signal form and consequently the limits for the test.

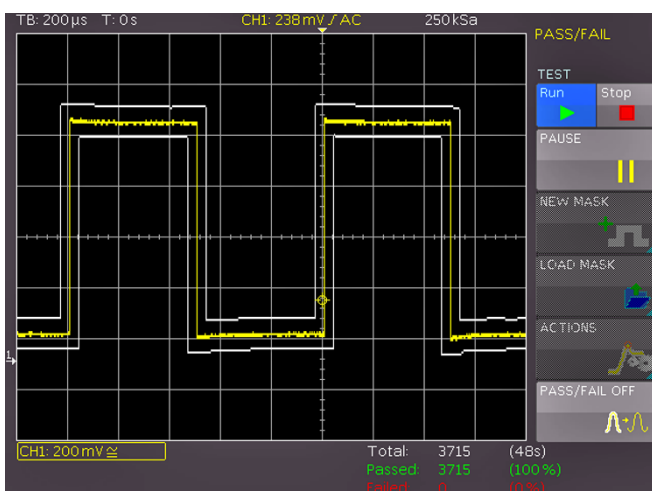

Fig. 9.8: PASS/FAIL mask test.

In the menu that opens you can use the key COPY CHANNEL to copy the current signal into a mask memory. The mask displays in white and appears as an overlay of the output signal. The menu keys Y-POSITION and STRETCH Y enable you to shift this curve vertically or to enlarge it. The two menu items WIDTH Y and WIDTH X allow you to

set the tolerance for the mask. The universal knob or the KEYPAD button in the CURSOR/MENU section are used to enter values with a resolution of 1/100 division. A mask includes a minimum and a maximum value for each captured data value. The minimum and maximum value for a source curve with only one value per data are identical. The width indicates the distance between the peripheral points and the original point. The greater the selected value is, the greater are the potential curve deviations in the amplitude. The tolerance mask is displayed in white in the background. The generated and edited mask can be used immediately for the test, however, it is only saved temporarily in the instrument storage. The soft menu key SAVE can be used to store the mask permanently to a USB stick or to the internal memory. Press the key MENU OFF to return to the start menu.

Press the soft menu key LOAD MASK to open a file browser which allows you to load previously stored masks for the test (file extension .HMK). A loaded mask can be changed in the menu NEW MASK. Changes will be applied to the file when the mask is edited and saved. Pressing the soft menu key ACTIONS in the PASS/FAIL main menu opens a menu with the available actions. The following four actions can be performed:

- Audio signal if the tolerance limits have been exceeded
- Stop for first-time failure (number is adjustable)
- Pulse for first-time failure (emits a pulse at the AUX output in case of failure)
- Screen dump for first-time failure on USB stick
- Screen dump for first-time failure on printer

An action is performed if the respective condition is met (e.g. a specific number of mask failures). Each action is assigned a unique condition which can be defined separately from the other actions. The respective condition can be defined in the menu for the corresponding action. Select the respective action by pressing the appropriate soft menu key; the corresponding soft menu item will be highlighted in blue. Press the MENU OFF key to return to the main menu and to start the mask test.

On the right below the display window you can view the total number and the total duration of the tests (in brackets) in white. The number of successful tests and their percentage (in brackets) are displayed in green, and the number of failures and their percentage (in brackets) are displayed in red. If a test has been started, the previously unavailable soft menu key PAUSE is now activated. Pressing the PAUSE key will interrupt the test while the acquisition of signals and the total duration are continued. If you press the PAUSE key again, the test will be resumed and all event counters continue to be incremented. If you deactivate a test by pressing the soft menu key Stop the event and time counters will be stopped. If a new test is started by pressing the soft menu key TEST activated (Run), all counters will be reset and resume at zero.

The PASS/FAIL mode is deactivated by pressing the soft menu key PASS/FAIL OFF.

## 9.5 Component Test



Fig. 9.9: HZ20 adapter connected to AUX OUT

The R&S®HMO1002 resp. R&S®HMO1202 series has a built-in component tester. This can be activated by pushing the UTIL button (VERTICAL section) with the soft menu key COMP. TEST. The unit under test is connected via AUX OUT connector and BNC/Banana adapter (e.g. HZ20). After switch on the component tester mode, the Y preamplifiers and the time base are disconnected. While using the component tester, signals may be present at the inputs as long as the unit under test is not connected to any other circuit. It is possible to test components remaining in their circuits, but in such cases all signals must be disconnected from the front panel BNC connectors (see the following paragraph: „Test in circuits“). The test principle is a generator within the R&S®HMO1002 resp. R&S®HMO1202 series generates a 50Hz or 200Hz ( $\pm 10\%$ ) sine wave which feeds the series connection of the test object and a sense resistor. If the test object has only a real part such as a resistor, both voltages will be in phase; the display will be a straight line, more or less slanted.

**If components are tested which are located in circuits or instruments, the circuits resp. instruments must be disconnected first! If they are operated from the mains, the mains plug of the test object has to be pulled out. This ensures that there will be no loops between the scope and the test object via the safety earth which might cause false results.**

Is the test object short-circuited, the line will be vertical (no voltage, current maximum). If the test object is open-circuited or missing a horizontal line will appear (voltage, but no current). The angle of the line with the horizontal is a measure of the resistance value, allowing for measurements of resistors between  $\Omega$  and  $k\Omega$ . Capacitors and inductors cause phase shift between voltage and current and hence between the voltages. This will cause displays of ellipses. The location and the form factor of the ellipse are determined by the apparent impedance at 50 Hz (resp. 200 Hz). Capacitors can be measured between  $\mu F$  and  $mF$ . An ellipse with its longer axis horizontal indicates a high impedance (small capacitance or large inductance). An ellipse with its longer axis vertical indicates a low impedance (large capacitance or small inductance). An ellipse with its longer axis slanted indicates a relatively large resistive loss in series with the impedance of the capacitor or inductor.

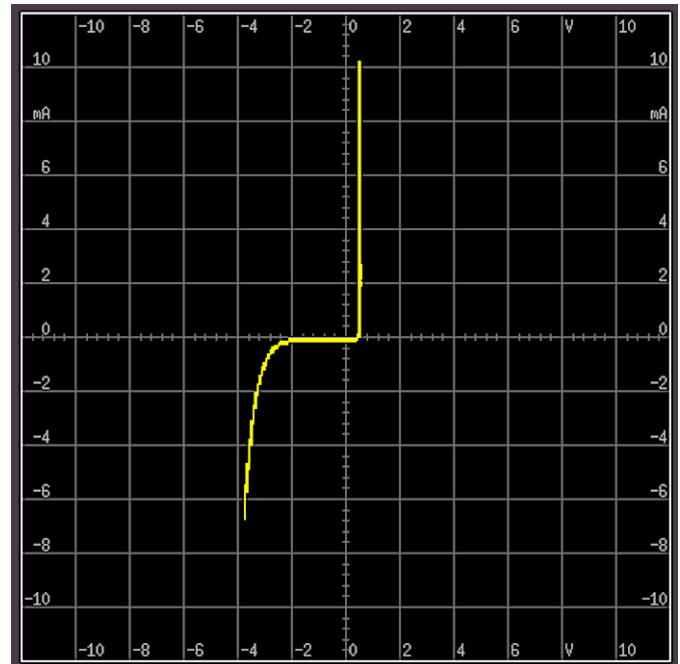

Fig. 9.10: Component test example.



**Only discharged capacitors may be tested!**

With semiconductors the transition from the non-conducting to the conducting state will be indicated in their characteristic. As far as is possible with the available voltages and currents the forward and backward characteristics are displayed (e.g. with zener diodes up to 9V). Because this is a two-pole measurement, the gain of a transistor can not be determined, however, the B-C, B-E, C-E diodes can be measured. With this exception the diodes can be measured without fear of destruction as the maximum voltage is limited to 9V and the current to a few mA. This implies, however, that a measurement of breakdown voltages  $> 9V$  is not possible. In general this is no disadvantage because, if there is a defect in a circuit, gross deviations are to be expected which will point to the defective component. Rather exact results may be achieved if the measurements are compared to those of intact components. This is especially true for semiconductors. The polarity of diodes or transistors can thus be identified if the lettering or marking is missing. Please note that with semiconductors changing the polarity will cause the display to rotate 180 degrees around the screen center. More important in practice is the quick determination of plain shorts and opens which are the most common causes of requiring service.

**It is highly recommended to observe the necessary precautions when handling MOS components which can be destroyed by static charges and even tribo electricity.**

### 9.5.1 In-circuit tests

They are possible in many cases but deliver rarely clear results. By paralleling of real or complex impedances – especially if those are fairly low impedance at 50Hz/200Hz – there will be mostly great differences compared to

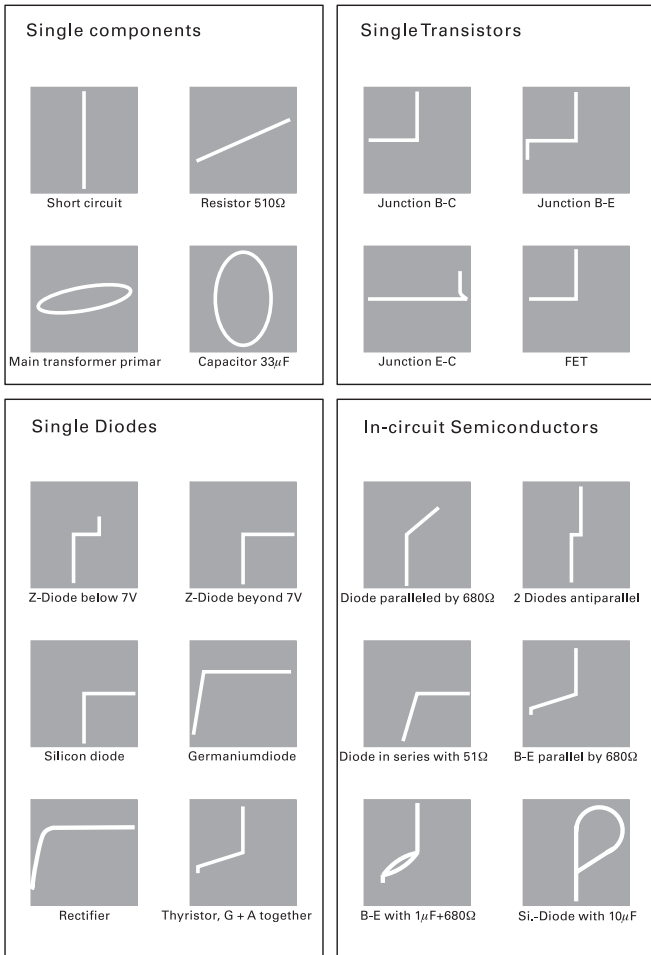

Fig. 9.11: Examples of Component test

individual components. If circuits of the same type have to be tested often (service), comparisons with intact circuits may help again. This is also quickly done because the intact circuit has not to be functional, also it should not be energized. Just probe the various test points with the cables of the component tester of the unit under test and the intact unit and compare the screen displays. Sometimes the unit under test may already contain an intact portion of the same type, this is e.g. the case with stereo circuits, push-pull circuits or symmetrical bridge circuits. In cases of doubt one side of the dubious component can be unsoldered.

### 9.6 Digital Voltmeter

The digital voltmeter completely captures input data with the selected vertical sensitivity and the basic accuracy of the ADC. The digital voltmeter is independent from the capture settings and the post processing of the transformer values. Determine the values by means of the measurement interval to ensure the defined frequency range of 20 Hz to 100 kHz. The measurement interval of the digital voltmeter is not corresponding to the acquisition time interval. Therefore, the measurement values of the digital voltmeter can not be the same like the measurement values of the AUTO MEASURE values.

The analysis function DIG. VOLTMETER can be activated by using the UTIL menu in the VERTICAL control panel. The

digital voltmeter includes a 3-digit voltage display as 7-segment display with the use of the analog channels. Four freely configurable measuring displays are possible where two measurement value displays for channel 1 (CH1) and two measurement value displays for channel 2 (CH2) are available. For each channel, the measurement displays are divided into in a primary measurement location (soft menu key Channel 1 / Channel 2) and a secondary measurement location (soft menu key SECONDARY). The primary measurement display will be shown in a large font, and the secondary measurement display in a small font. All measurement displays can be configured separately.

The following primary and secondary measurement displays are available:

- ▮ OFF: Measurement display deactivated
- ▮ DC: Mean
- ▮ DC RMS: RMS
- ▮ AC RMS: Standard Deviation
- ▮ CREST FACTOR: Crest factor ( $|X|_{max}/X_{RMS}$ )
- ▮ PEAK PEAK: Maximum-Minimum
- ▮ PEAK +: Maximum
- ▮ PEAK -: Minimum

Use the soft menu key POSITION to change the display position of the digital voltmeter on the screen. When the XY mode is activated, the display position of the digital voltmeter is predefined and cannot be modified. Use the soft menu key VOLTMETER OFF to deactivate the digital voltmeter function and to close the menu.

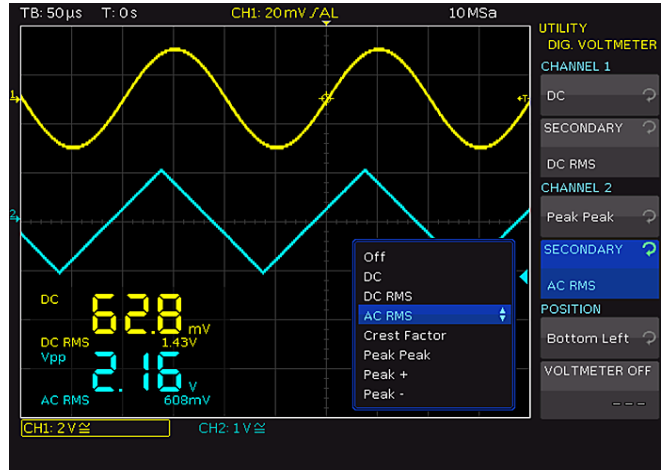

Fig. 9.12: Digital Voltmeter.

# 10 Signal Generation

## 10.1 Function Generator

The R&S®HMO1002 resp. R&S®HMO1202 series includes an integrated function generator which can generate input signals while testing circuits, for instance. To activate the function generator, select the UTIL menu in the VERTICAL control panel, and then press the soft menu key FUNCTION GEN. The following waveforms can be generated and made available at the AUX OUT connector:

- **DC**
- **SINE**: Frequency range from 0.1 Hz to 50kHz
- **SQUARE WAVE**: Frequency range from 0.1 Hz to 50kHz
- **PULSE**: Frequency range from 0.1 Hz to 10kHz
- **TRIANGLE**: Frequency range from 0.1 Hz to 10kHz
- **RAMP**: Frequency range from 0.1 Hz to 10kHz

Use the soft menu key FREQUENCY to select the signal frequency, and use the soft menu key AMPLITUDE to select the signal amplitude via universal knob or numerically via KEYPAD key in the CURSOR/MENU control panel. You also have the option to select a DC offset (soft menu key OFFSET). An information box shows a preview of the respective signal form with the selected parameters. Use the soft menu key OFF to deactivate the function generator and to close the menu.

## 10.2 Pattern Generator

The pattern generator includes the output of parallel patterns on the four pins S0 to S3 on the front panel of the instrument. It is based on a 2048 bit wide memory (Samples) which can be issued cyclically / individually. All sub functions of the PATTERN GENERATOR are based on this memory. It is not possible to issue multiple functions simultaneously. An information box shows which pins to use. The pattern generator menu (pattern generator) includes various options. Use the UTIL menu in the VERTICAL control panel and press the soft menu key PATTERN GEN. to open it.

Function	Setting options
<b>Square wave</b>	Frequency / Period, Polarity, Duty Cycle
<b>Counter</b>	Frequency, counting direction
<b>Arbitrary</b>	Timing, pattern input
<b>Manual</b>	Manual switching of the 4 individual connectors
<b>UART</b>	Polarity, setting the bit rate
<b>SPI / I<sup>2</sup>C / CAN / LIN</b>	Setting the bit rate

Tab. 10.1: Settings options for the pattern-generator

## 10.2.1 Square Wave

Use the soft menu SQUARE WAVE to perform a manual probe compensation without compensation wizard. The square wave function uses a 100-sample wide pattern (100 conditions). Additionally, you can change the polarity and the duty cycle (1% to 99%).

## 10.2.2 Counter

A 4 bit wide counter pattern is issued. The user can determine the counting direction (soft menu key DIRECTION) and the frequency (soft menu key FREQUENCY). The user frequency always refers to the switching of the pattern condition. This results in square waveforms for individual pins, as described in Tab. 10.2.

Pin	Frequency
<b>S0</b>	f/2
<b>S1</b>	f/4
<b>S2</b>	f/8
<b>S3</b>	f/16

Tab. 10.2: Counter

## 10.2.3 Arbitrary

The user can define a 4 bit wide and a 2048 sample deep pattern via soft menu ARBITRARY. The created patterns can be stored or recalled. If the arbitrary function is activated, the predefined pattern, which may have been generated automatically, will be retained. This means that a SPI pattern can be analyzed and adapted as necessary.

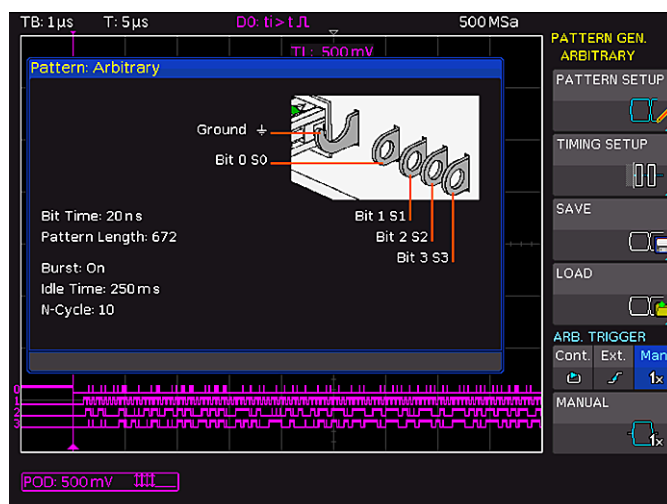

Fig. 10.1: Arbitrary menu

The following settings options are available:

### ■ PATTERN SETUP:

Use the soft menu key PATTERN LENGTH to determine the pattern depth. Use the INDEX and the universal knob or the KEYPAD key in the CURSOR/MENU control panel to select individual samples. The selected sample will be shown in the information box as a light blue line. To select a sample, also use the universal knob or the KEYPAD key. The pattern flow for all 4 bits will be shown in the window. Around the index,  $\pm 8$  bits will be displayed. Use the soft menu key VALUE to change the value of the selected sample. Use the soft menu key DRAW to draw large sample amounts with the same value. The VALUE setting remains unchanged and is applied to all selected indices. If the pattern is deleted (soft menu key DELETE ALL), its length will be reset to 1. All connectors will be set to ,0'.

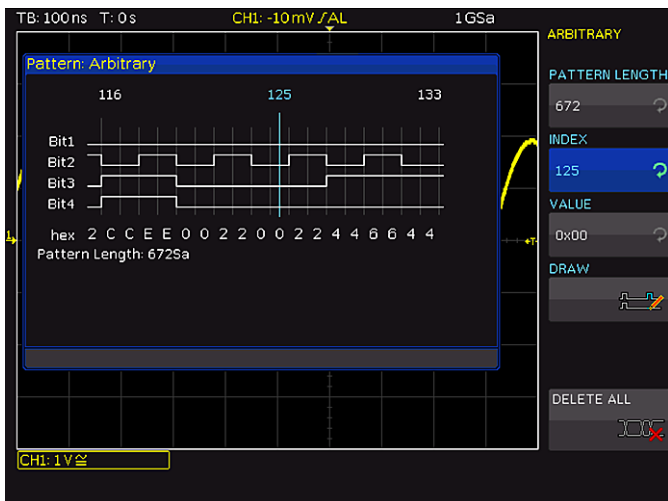

Fig. 10.2: Arbitrary pattern setup

### ■ TIMING SETUP:

Use the soft menu key BIT TIME to set the time at which you would like each sample to be applied. The time is identical for all samples. The configurable PERIOD applies to the entire pattern and is calculated by its length multiplied by its bit time (time of a sample). If the BURST function is activated (ON), the instrument will pause after each issued pattern for the duration of the IDLE TIME. Only then will the pattern be issued again. Setting the N-CYCLE option enables the user to issue the pattern precisely <n> times. The sample time can be set from 20ns to 42s in increments of 10ns. It will be implemented by means of a 32 bit counter. The IDLE TIME between the patterns can be set from 20ns to 42s in increments of 10ns. It will also be implemented by means of a 32 bit counter. Use the universal knob or the KEYPAD key in the CURSOR/MENU control panel to enter the values.

### ■ SAVE/RECALL:

The manually created pattern can be saved or recalled via soft menu SAVE or RECALL. The pattern can be stored internally or externally on a connected USB stick. The pattern and the time settings will be saved.

### ■ ARB. TRIGGER:

The soft menu key ARB. TRIGGER makes three possible trigger functions available. The CONT. option (continuous trigger) issues the pattern continuously. If the BURST function is activated, only the IDLE TIME is applied between the patterns. The N-CYCLE setting is voided by the continuous output. For the EXT. (external trigger) setting, the pattern is issued by an edge at the external input of the oscilloscope (TRIG. EXT.). If the BURST function is activated, the pattern will be issued <n> times (see N-CYCLE). In addition, you are able to determine the direction of the triggering edge. If BOTH is selected as slope direction, both edges are of equal value. The first edge triggers the pattern. The edges do not alternate. If the MAN. setting is activated, the pattern is issued manually by pressing the respective key. If the BURST function is activated, IDLE TIME and N-CYCLE apply.

## 10.2.4 Manual

In the manual pattern mode, the modes of the individual pins S0 to S3 are wired separately. Each pin is assigned to a specific soft menu key and the condition HIGH (H) or LOW (L) is selected.

## 10.2.5 BUS Signal Source

Use the pattern generator connectors on the front panel of the instrument to generate the following BUS signals (for measurements without measurement object), depending on the setting:

- **SPI:** Data rate 100kBit/s, 250kBit/s or 1 MBit/s
- **I<sup>2</sup>C:** Data rate 100kBit/s, 400kBit/s, 1 MBit/s or 3.4 MBit/s
- **UART:** Data rate 9600 Bit/s, 115.2kBit/s and 1 MBit/s
- **CAN:** up to 50 MBit/s
- **LIN:** up to 50 MBit/s

**The signals of the BUS signal source are pseudo random pattern and are not adaptable. Only the BUS type and the data rate can be selected.**

The contact at the upper left is always ground and the signal levels are about 1V. The following table shows how the four outputs S1, S2, S3 and S0/⌈ are used, depending on the signal.

Signal	S1	S2	S3	S0/⌈
<b>SPI</b>	Clock	MOSI	MISO	Chip Select
<b>I<sup>2</sup>C</b>	Data SDA	no signal	no signal	Clock SCL
<b>UART</b>	RX	no signal	no signal	TX
<b>CAN</b>	CAN L	no signal	no signal	CAN H
<b>LIN</b>	Low	no signal	no signal	High

Tab. 10.3: Pin assignment of the BUS signal source

An information box is displayed for each operating mode, displaying the corresponding connector assignment. By pressing the respective soft menu key, you can open a submenu with the bit rate setting of the selected operating mode.

In the SAVE/RECALL menu you can load via soft menu DEVICE SETTINGS and the soft menu key LOAD predefined SPI/SSPI, I<sup>2</sup>C, UART, CAN and LIN BUS signal source configuration files from internal memory.



# 11 Documentation, Storage and Recall

The oscilloscope allows all screen displays that store user settings (e.g. trigger condition and time base setting), reference curves and curves. An internal memory integrated with the instrument is available for reference curves and instrument settings. Screenshots and curve data can also be stored on a connected USB stick.

**The USB stick should not exceed 4 GB and must be FAT formatted (FAT16/32). It should be avoided to store a large number of files on the USB stick.**

You can access the main menu to store and load functions by pressing the SAVE/RECALL key in the GENERAL section.

## 11.1 Device Settings

The soft menu DEVICE SETTINGS allows you to save current instrument settings load saved settings and import or export instrument settings.

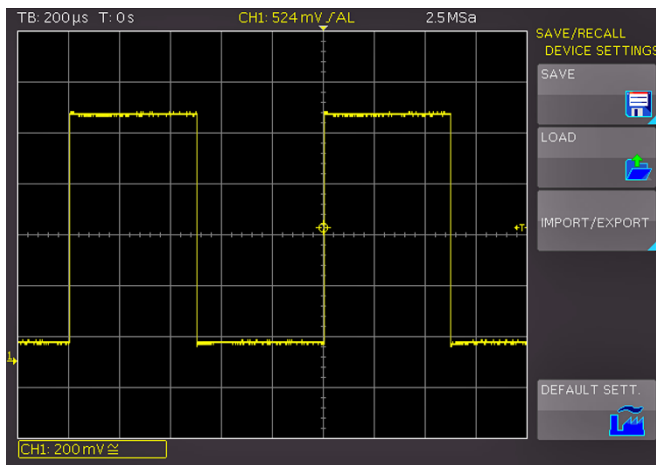

Fig. 11.1: Basic menu for instrument settings

Press the soft menu key SAVE to open the Save menu. You can use the soft menu key STORAGE to select a possible location (internal memory or front USB connection) where you would like to save the instrument settings. Pressing this key opens the file manager. The FILE NAME can be changed or adjusted to the corresponding setting (SET is the default label). You can use the soft menu key COMMENT to enter a comment which will be displayed in the file manager footer once a file has been selected. The option SAVE allows you to store the settings. To reload stored preference files, press the respective soft menu key to open the soft menu LOAD. This opens the file manager where you can use the universal knob to select the respective file. Once the storage location and the respective settings file has been selected, you can load the file by

**Device settings of an older firmware version in SCP format can be loaded with a newer firmware version.**

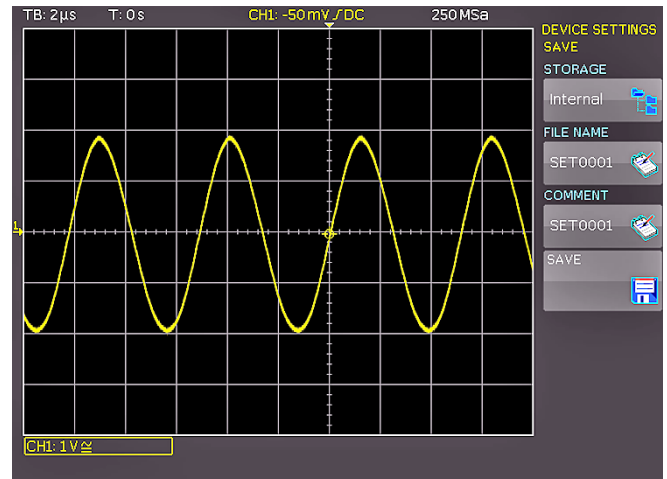

Fig. 11.2: Storing instrument settings

pressing the soft menu key LOAD. To remove files that are no longer required you can use the universal knob to select the respective settings file and remove it by pressing the soft menu key REMOVE FILE. If a USB stick is connected, you can also change and delete directories. Use the soft menu key SORT ENTRIES to sort several settings files by name, type, size or date.

**To import or export instrument settings, you must have a USB stick connected, otherwise the menu cannot be selected.**

The soft menu IMPORT/EXPORT allows you to copy a file from an internal memory to an external storage medium (USB stick) or vice versa. Source (SOURCE FILE) and target (DEST. PATH) must be selected for copying. Use the universal knob to select a storage location which will open a file manager. Pressing the IMPORT/EXPORT key by default will copy the selected settings file.

The menu item DEFAULT SETT. also allows you to load the factory default settings.

## 11.2 References

References are data sets which consist of settings information and A/D converter data. These may be stored and reloaded internally or externally. Data can be reloaded into one of the 4 reference memories (RE1 to RE4) which can also be displayed. The main feature of references is the fact that all information (e.g. vertical gain, time base setting, A/D converter data) is included when saving or reloading, enabling a comparison between the original signal and its corresponding values.

The soft menu REFERENCES only allows you to import or export references (IMPORT/EXPORT). The transfer of references to other R&S®HMO instruments is possible. The standard menu for the file manager opens which allows you to copy references between the internal memory and the external USB stick. The top soft menu SOURCE allows you to use the universal knob in the CURSOR/MENU section to select the source for the reference to be saved. You can select from the activated channels and mathematical curves. Open the menu to store and load by pressing the REF key in the VERTICAL section of the control panel.

With the soft menu key RE1 to RE4 up to 4 references can be activated. The top soft menu SOURCE allows you to use the universal knob to select the source for the reference to be saved. You can select from the activated channels and mathematical curves. Press the soft menu key DISPLAY to display the selected reference curve or to update the current reference curve.

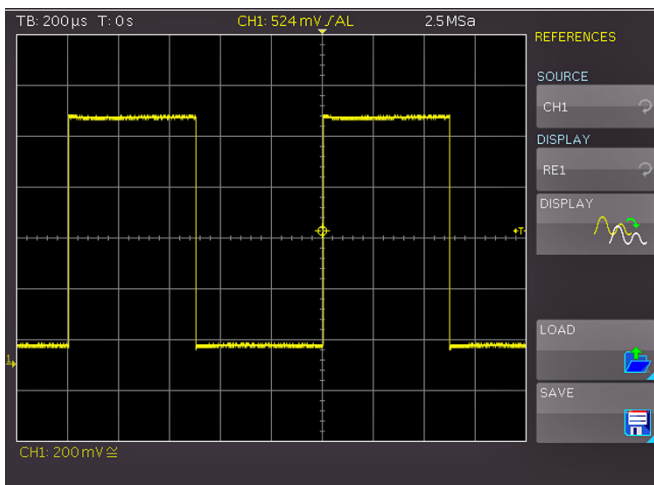

Fig. 11.3: Storage menu for references

To load a reference from a USB stick or the internal memory, open the soft menu LOAD. This shows a window displaying the internally stored references. You can select the desired target reference curve in the top menu item and by pressing LOAD in the file manager. To complete loading and displaying the reference, press LOAD in the file manager menu again. To save a reference, press the SAVE key, determine the source, storage location, file name and curve, and press the soft menu key SAVE (with the disk icon). The FILE NAME can be changed or adjusted to the corresponding setting (REF ist the default label). You can use the soft menu key COMMENT to enter a comment which will be displayed in the file manager footer once a file has been selected.

### 11.3 Traces

In addition to references, you can also store A/D converter data. Traces can only be stored to externally connected USB sticks (not internally). Depending on the selected time base and sample rate in the ACQUIRE menu (AUTOMATIC, MAX. SAMPLE RATE or MAX. WAVEFORM RATE) the maximum read-out measurement points varies..

**The full memory can only be read out in STOP mode with the maximum sampling rate setting (ACQUIRE menu).**

In the soft menu STORAGE the USB connection on the front of the instrument is selected as storage location. Selecting the respective storage location is possible when a USB stick has been recognized. If a USB stick is connected, you can also change, create or delete directories. Use the soft menu key SORT ENTRIES to sort several settings files by name, type, size or date. Press ACCEPT DIR. to confirm the target directory and you will automatically return to the curve main menu.

The soft menu TRACES allows you to use the universal knob in the CURSOR/MENU section to select a channel which will be saved as a curve. You may only select channels that have been activated via channel keys. You can also save all visible channels simultaneously.

**Saving of all visible channels is only possible with the CSV format and can not be changed.**

The soft menu key FILE NAME opens the menu for the name entry, where you can use the universal knob or the KEYPAD key in the CURSOR/MENU section to enter a name and confirm your entry by pressing ACCEPT (TRC is the default name). The curve main menu will display automatically. You can open a selection window by pressing the soft menu key FORMAT to determine the file format. The universal knob in the CURSOR/MENU section allows you to select the desired format. You can choose from the following formats:

#### ■ BIN (MSB/LSB):

A binary file may contain any type of Byte value. The captured curve data will be stored without any time information.

#### ■ FLT (MSB/LSB):

A FLT file contains the captured data as voltage values. Compared to a FLT file, the captured amount of data for a CSV file is 16 times greater. The voltage values are stored in the Float format (4 Byte Float, binary, Big Endian). This file can be reused in programs written by users, for instance.

#### ■ CSV (Comma Separated Values):

In CSV files, curve data is stored in table format. Each table row is separated by a comma.

#### Example: Trace with all visible channels

```
[s],CH1[V],CH2[V]
-4.99500E-07,-2.601E-03
-4.99000E-07,-6.012E-04
-4.98500E-07,-6.012E-04
-4.98000E-07,1.399E-03
```

**If you choose the "Max. Sampling Rate" in the ACQUIRE menu, two rows will be affixed with a time stamp during the CSV export because a minimum and a maximum value must be assigned to this time value. To acquire an amplitude value per time stamp, activate "Automatic" in the ACQUIRE menu.**

#### ■ TXT:

TXT files are ASCII files that only contain amplitude values (no time values). Amplitude values are separated by a comma. The value pairs are listed as single values without identification.

#### Example:

```
1.000E-02,1.000E-02,1.000E-02,1.000E-02,3.000E-02
```

You can use the universal knob in the CURSOR/MENU section to select in the soft menu POINTS whether to read out the display memory or the entire acquisition memory. You can use the soft menu key COMMENT to enter a

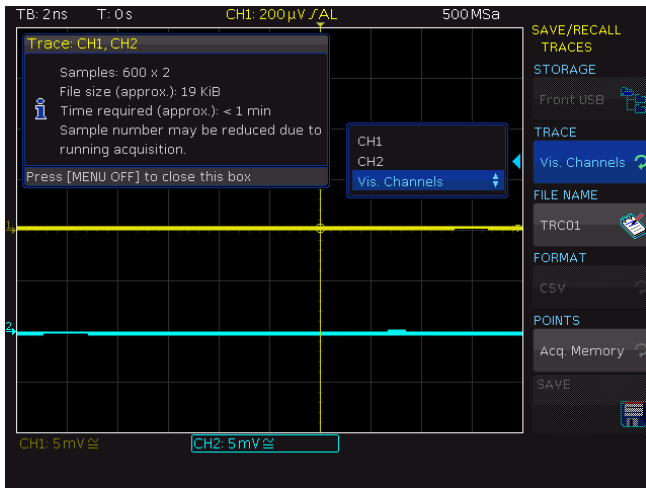

Fig. 11.4: Trace storage menu

comment which will be displayed in the file manager footer once a file has been selected. After you made all entries, press the menu key STORE to save the selected curve(s) according to the settings.

## 11.4 Screenshots

The most important format to store information for documentation purposes is the screenshot. A screenshot is an image file which shows the current screen content at the time that storage takes place. The soft menu STORAGE only allows you to use the USB connection on the front as storage location. Selecting the respective storage location is possible when a USB stick has been recognized. If a USB stick is connected, you can also change, create or delete directories. Use the soft menu key SORT ENTRIES to sort several settings files by name, type, size or date. Press ACCEPT DIR. to confirm the target directory and you will automatically return to the screenshot main menu. The soft menu key FILE NAME opens the menu for the name entry where you can use the universal knob or the KEYPAD key in the CURSOR/MENU section to enter a name and confirm your entry by pressing ACCEPT (SCR is the default name). The screenshot main menu will display automatically. The file format of a graphics file determines the color depth and the type of compression. The quality of the various formats is identical for the oscilloscope graphics. You can choose from the following file formats in the soft menu FORMAT:

- **BMP** = Windows Bitmap Format
- **GIF** = Graphics Interchange Format
- **PNG** = Portable Network Graphic

With the soft menu key COLOR MODE and the universal knob in the CURSOR/MENU section you can choose from the following color modes:

### ■ GRAYSCALE:

If GRAYSCALE is selected, the colors are converted to gray scales when the waveform is stored

### ■ COLOR:

If COLOR is selected, the waveform is stored as it displays in the screen,

### ■ INVERT (HG):

If INVERT (HG) is activated, waveform is stored in color with an inverted background.

### ■ INVERT (BG, GRAY):

If INVERT (BG, GRAY) is activated, the waveform is stored in gray with an inverted background.

### ■ INVERT (ALL):

If INVERT (ALL) is activated, the waveform and background are stored inverted.

### ■ INVERT (ALL, GRAY):

If INVERT (ALL, GRAY) is activated, the waveform and background are stored in gray.

If you press the key SAVE, the current screen will be saved immediately to the selected storage location with the selected name and format.

## 11.4.1 Printer

The soft menu key PRINT allows you to print a screenshot immediately to a connected printer. PCL-5, PCL-XL (= PCL-6) and Postscript settings are supported as „printer language“ (PCL-3 is not supported). If a printer is detected, the soft menu key PRINT will no longer be grayed out.

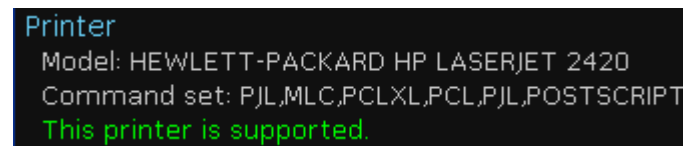

Fig. 11.5: Supported printer example

The supported printer will be displayed in the soft menu DEVICE INFOS. The message „This printer is supported“ does not guaranteed the the connected printer will be supported. This message only means that the USB printer connection was successful and the important printer properties are available.(e.g. printer language PCL or PCL-XL). Connected PLC printers send an identification string to the instrument. This identification string should be for all printers the same (standard), but there are many printers on the market, which have another identification string. In this case, the instrument is not able to detect the printer because the instrument does not have a Windows system internally to handle the identification string deviation.

**Press the RUN/STOP key to stop acquisition prior to printing which will allow a correct printout.**

If a printer connection is not possible, you have the possibility to use the HME Explorer software with the screenshot software module. The free software HMScreenshot (software module of the HME Explorer software) enables the transfer of screenshots in bitmap format from the device via interface to a connected PC where the screenshots may then be saved or printed. For additional information on the software, refer to the internal HME Explorer software manual.

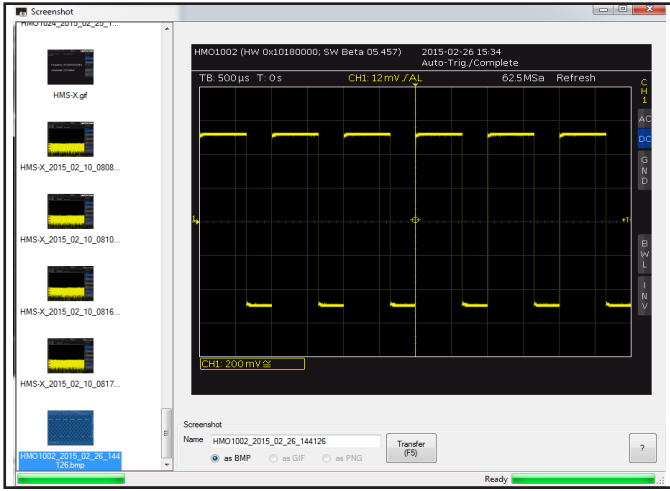

Fig. 11.6: Screenshot module

### 11.5 FILE/PRINT Key Definition

The FILE/PRINT key in the GENERAL section allows you to save instrument settings, curves, screenshots and screenshot settings simultaneously with just one key. As described in previous chapters, you must first select the corresponding settings for storage location, name etc. The soft menu key FILE/PRINT in the SAVE/RECALL main menu opens the setup menu for the FILE/PRINT key. You may choose from the following actions:

- ▮ **DEVICE SETTINGS:** Stores settings
- ▮ **TRACES:** Stores curves
- ▮ **SCREENSHOTS:** Stores screenshots
- ▮ **SCREEN & SETUP:** Stores screenshots and settings
- ▮ **PRINT:** Prints directly to a compatible printer (Postscript, some PCL and PCLX capable printer)

If you press the respective soft menu key to activate the required operation, the corresponding menu will be displayed with a blue background. Press the MENU OFF key to quit the selection menu. If you press the FILE/PRINT key, the selected function will be performed.

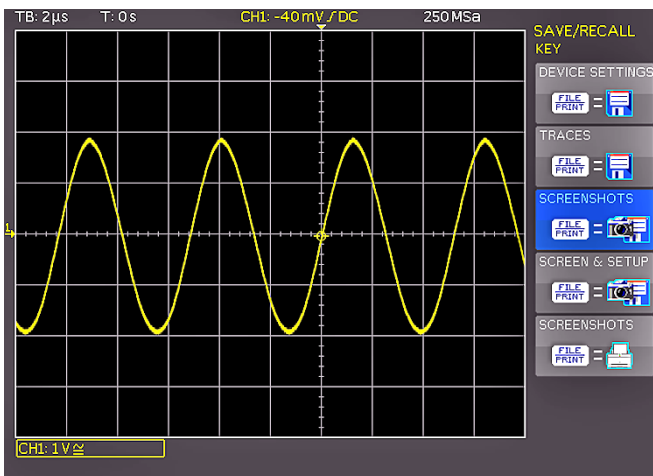

Fig. 11.7: Definition of FILE/PRINT key

# 12 Mixed-Signal Operation

As a standard, the R&S®HMO1002 resp. R&S®HMO1202 series is equipped with the connectors for the R&S®HO3508 logic probe to add 8 digital logic inputs. All software required for the mixed signal operation is already included in the firmware of the R&S®HMO1002 resp. R&S®HMO1202 series. It is only necessary to purchase and connect the active R&S®HO3508 logic probe (8 channels). If you activate the POD on R&S®HMO1002 series, analog channel 2 will be deactivated automatically. This only allows the configuration of 1 analog channel + 8 logic channels on the screen simultaneously. The R&S®HMO1202 series allows the configuration of 2 analog channels + 8 logic channels on the screen simultaneously.



Fig. 12.1: Optional logic probe R&S®HO3508

## 12.1 Logic Trigger for Digital Input

Please find an additional description of the logic trigger for the inputs of the logic probe in chapter 6.3.3.

## 12.2 Display Functions for the Logic Channels

You must always set the level to distinguish between the logic states (High/Low) in the VERTICAL MENU..

To switch on the digital channels, press the POD key in the VERTICAL section. The digital channels 0 to 7 will now display on the screen. For the logic channels, a logic „1“ will be indicated by a bar that is two pixels wide, and a logic „0“ will be indicated by a bar that is one pixel wide. The set logic level and a figure which shows the logical states will be shown next to the name POD in the information field in the bottom left of the display.

You may now choose the Y position and the size of the logic channel display just as you would for the analog channels. Use the knobs Y-POSITION [18] and VOLTS/DIV [20] to select the settings (if the soft menu key "0/7" is selected, indicated by a blue background). If you wish to display fewer than 8 logic channels or change the position and size of a particular logic channel, you can use the short menu in combination with the soft menu keys (channel 0 to 7) and the buttons Y-POSITION [18] and VOLTS/DIV [20] to select the respective settings. You can choose a channel by pressing the ▲ and ▼ soft menu keys. This allows you to resize and position specific channels individually.

You can reset the position and size of the individual logic channels on page 2|2 of the POD menu. You also have the option to label the individual bits of the logic channel by using the soft menu NAME. This name will be displayed on the grid and the printout. Your first option is to switch the display on (ON) or off (OFF). The next option includes the menu item LIBRARY. After selecting this option, you can use the universal knob to choose a name from several suggestions. The EDIT LABEL key allows you to enter a completely new name or to customize the suggested name. You may enter up to 8 characters. Use the ACCEPT key to confirm the name in the editor. It will then be shown in the display. The name is assigned to that specific signal and will move alongside any set offset value.

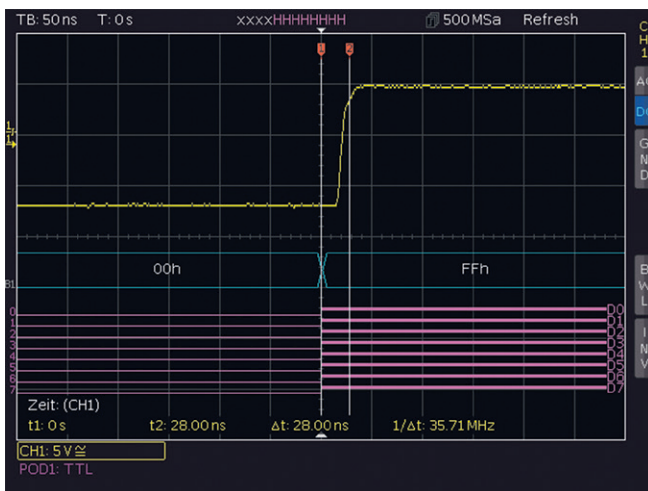

Fig. 12.2: 8 Bit DAC signal change

### 12.3 Display of Logic Channels as BUS

You also have the option to combine digital channels to form buses which will then be displayed on the screen as a cell in a table. Basically, two independent buses are possible. For instance, it would be possible to combine an 8 bit address bus and an 8 bit data bus. To select the settings for the buses, press the BUS button in the VERTICAL section. Then press the MENU button in the VERTICAL section. In the menu that opens you can press the top soft menu key BUS to select which BUS you want to define, B1 or B2. You can use the soft menu key BUS TYPE to choose the BUS type for the display and the analysis. The BUS type determines the bus structure and is organized differently depending on serial vs. parallel or the number

of data and clock signals. The universal knob allows you to select the BUS type PARALLEL or PARALLEL CLOCKED. Select CONFIGURATION to determine the bus source and structure. The contents of the menu change with the selected BUS type. After pressing the top soft menu key BUS WIDTH, you can use the universal knob to select a bus width from 1-8 bits. The table displaying the bit assignments will be adjusted dynamically depending on your choice. Each bit of the displayed bus has a source. The source refers to the individual POD bits. Based on the measurement setup, the sources can be assigned via soft menu key SOURCE and the universal knob in the CURSOR/MENU section.

The soft menu keys PREVIOUS/NEXT BIT allow you to move the position of the selection bar for the source of the individual bits. The selected bit is highlighted in blue. The left side of the table contains the bits in fixed sequence, beginning at the top with D0 (= LSB). The universal knob allows you to assign a real logic channel to the selected BUS bit. The allocation is not subject to restrictions; you can also use partially identical logic channels in the two possible buses. If you select PARALLEL CLOCKED as BUS TYPE, you can also use the bottom soft menu key CONTROL WIRES to select sources for CHIP SELECT, and you can use the universal knob to select the settings for CLOCK. The soft menu key ACTIVE is used to determine if the chip select signal High or Low Active is selected. The soft menu key SLOPE allows you to toggle between rising, falling and both slopes. The active selection is always highlighted in blue and is listed after the label CLK in the bit source window. Press the MENU OFF button to return to the BUS main menu.

The soft menu DISPLAY SETUP opens a menu to select the display format and its extent. The universal knob in the submenu allows you to choose the format to decode the bus values. You can choose from the following formats:

- Binary
- Hexadecimal
- Decimal
- ASCII

The decoded values will be shown in the cells/tables of the buses according to the selected format. The next soft menu key BITS can also be used to activate (ON) or deactivate (OFF) the table display for the individual bus bits. You can use the POSITION control knob to determine the position of the bus display on the screen. The VOLT/DIV knob allows you to determine the size of the table display. This may be particularly useful for the binary display as it allows the display of the complete value in up to 4 rows even for short tables.

### 12.4 Cursor Measurements for Logic Channels

If the logic channels are activated, you may select several parameters via cursor measurements (CURSOR MEASURE button). For all activated logic channels of a POD, you can choose from the following measurement types:

**I TIME:**

The display will include the time position of both cursors relative to the trigger time, the time difference between the two positions and the resulting frequency.

**I RATIO X:**

In this measurement type, three cursors are used to display a time ratio between the first two cursors plus the first and third cursor. The results are shown in floating point format, in percent, in degrees and in radians.

**I V-MARKER:**

For the logic channels, the logic value of the selected POD will be measured at the respective cursor and shown in hexadecimal and decimal format.

**12.5 Automatic Measurements for Logic Channels**

If the logic channels are activated, you can use the automatic measurement functions to determine several parameters. For all activated logic channels of a POD, you can choose from the measurement types:

**I FREQUENCY****I PERIOD****I PULSE WIDTH +/-****I DUTY CYCLE +/-****I DELAY****I PHASE****I BURST WIDTH****I COUNT PULSE +/-****I COUNT (pos./neg.)**

# 13 Serial Bus Analysis

**13.1 Software options (license key)**

The R&S®HMO1002 resp. R&S®HMO1202 series can be upgraded with options / voucher to trigger and decode serial buses.

**I R&S®HOO10 / R&S®HV110:**

The option R&S®HOO10 resp. the voucher R&S®HV110 can be used to trigger and decode I<sup>2</sup>C, SPI and UART/RS-232 buses on the digital channels (option logic probe R&S®HO3508 needed) and on the analog inputs. This option allows the decoding of two serial buses simultaneously.

**I R&S®HOO11 / R&S®HV111:**

The option R&S®HOO11 resp. the voucher R&S®HV111 can be used to trigger and decode I<sup>2</sup>C, SPI and UART/RS-232 buses on analog inputs only and it only allows the decoding of one serial bus at a time.

**I R&S®HOO12 / R&S®HV112:**

The option R&S®HOO12 resp. the voucher R&S®HV112 can be used to trigger and decode CAN and LIN buses on the digital channels (option logic probe R&S®HO3508 needed) and on the analog inputs. This option allows the decoding of two serial buses simultaneously.

The options R&S®HOO10, R&S®HOO11 and R&S®HOO12 can be ordered in combination with a R&S®HMO1002 ex factory. The upgrade voucher R&S®HV110, R&S®HV111 and R&S®HV112 can be activated by a software license key (please refer to chapter 2.7).

The analysis of parallel and serial data consists of the following three basic steps:

**I Protocol configuration** (BUS type / protocol-specific settings)

**I Decoding** (Display of decoded data / Zoom / BUS table)

**I Trigger** (Start / Stop / serial samples)

**The serial bus analysis is performed with 1/8 of the sampling rate.**

**13.2 Serial Bus Configuration**

**Prior to the BUS configuration it is necessary to set the correct logic level (threshold). Please refer to chapter 4.5. The default setting is 500 mV.**

It is necessary to define a BUS before you can determine the settings for the serial trigger and decoding functions. A maximum of two buses, B1 and B2, may be defined. Press the BUS button in the VERTICAL section. This will open a short menu where you can press the bottom soft menu key B1 or B2. Additionally you can use the MENU button in the VERTICAL section and the top soft menu key to define

the respective BUS (B1 or B2).

Depending on the installed option use the soft menu key BUS TYPE to choose from the following BUS types:

- ▮ **PARALLEL** (Standard)
- ▮ **PARALLEL CLOCKED** (Standard)
- ▮ **SSPI** (only available with R&S®HOO10/HV110/HOO11/HV111)
- ▮ **SPI** (only available with R&S®HOO10/HV110/HOO11/HV111)
- ▮ **I<sup>2</sup>C** (only available with R&S®HOO10/HV110/HOO11/HV111)
- ▮ **UART** (only available with R&S®HOO10/HV110/HOO11/HV111)
- ▮ **CAN** (only available with R&S®HOO12/HV112)
- ▮ **LIN** (only available with R&S®HOO12/HV112)

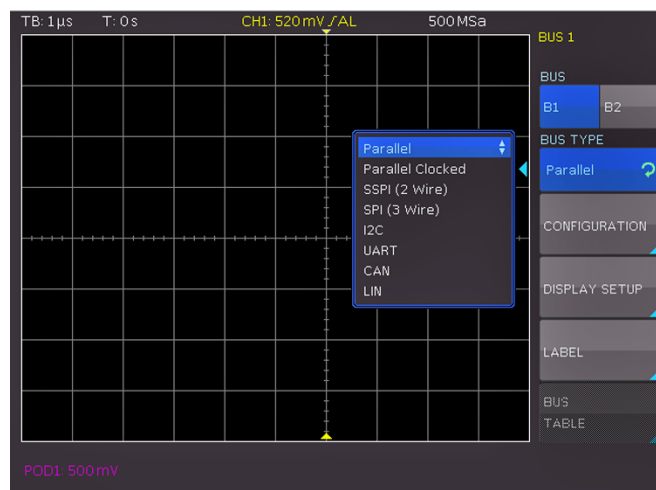

Fig. 13.1: Menu for the definition of buses

The soft menu key CONFIGURATION allows you to invoke a menu corresponding to the selected bus type. A menu description can be found in the chapters of the respective BUS configuration. The soft menu DISPLAY SETUP is identical for all buses and allows you to select the decoding format. You may choose from the following formats:

- ▮ **Binary**
- ▮ **Hexadecimal**
- ▮ **Decimal**
- ▮ **ASCII**

Use the soft menu key BITS to activate or deactivate the display of individual bit lines (above the table display). The last entry NAME in the VERTICAL menu opens a submenu which allows you to enter a BUS name. This name will be displayed on the grid and the printout. Your first option is to switch the display on (ON) or off (OFF). The next option includes the menu item LIBRARY. After selecting this option, you can use the universal knob to choose a name from several suggestions. The EDIT LABEL key allows you to enter a completely new name or to customize the suggested name. You may enter up to 8 characters. Use the ACCEPT key to confirm the name in the editor. It will then be shown in the display. The name is assigned to that specific signal.

### 13.2.1 BUS Table

The soft menu BUS TABLE allows you to configure / export a list of all decoded messages in storage. The table content is protocol specific and the table display can be activated for each individual BUS type. The top soft menu

key BUS TABLE allows you to activate or deactivate the list view (blue highlighted). By default, the table is displayed at the bottom of the screen. Generally, a complete message of a protocol is displayed in a row. The columns include important information, e.g. address and date of the message. The number of rows in the table is identical to the number of complete message frames in storage. The decoding results may be saved as CSV file by using the soft menu key SAVE (e.g. save to a USB stick).

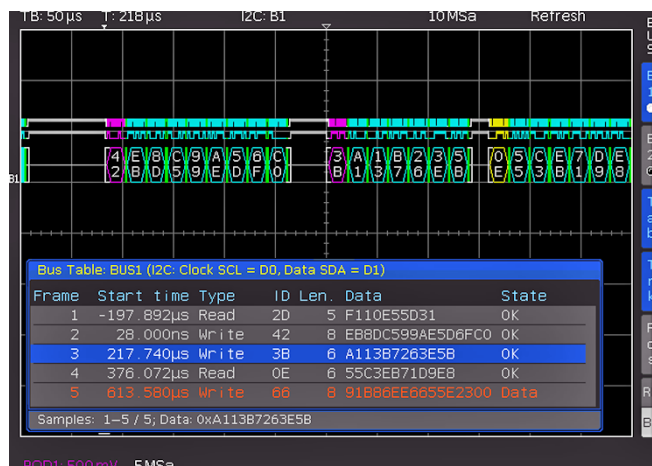

Fig. 13.2: Example I<sup>2</sup>C BUS with BUS table

**Make sure that a complete message of a serial protocol is always displayed on the screen to ensure decoding can function properly. The Zoom function allows you to view details for any specific message.**

#### Example of a I<sup>2</sup>C BUS table:

“Bus table: BUS1 (I2C: Clock SCL = D0, Dates SDA = D1)”  
 Frame,Mark,Start time[s],Type,ID,Length,Date,Condition  
 1,-197.89200e-6,Read,0x2D,5,0xF110E55D31,OK  
 2,,28.00000e-9,Write,0x42,8,0xEB8DC599AE5D6FC0,OK  
 3,,217.74000e-6,Write,0x3B,6,0xA113B7263E5B,OK  
 4,,376.07200e-6,Read,0x0E,6,0x55C3EB71D9E8,OK  
 5,,613.58000e-6,Write,0x66,8,0x91B86EE6655E2300,Data Error

**A BUS table can only be stored if the STOP mode is active.**

The soft menu key TRACK FRAME allows you to scroll through the BUS table and simultaneously jump to the corresponding position in the memory via universal knob to display details on the screen. However, this is only possible if acquisition has been stopped. This option is also available in the short menu BUS via soft menu key TRK (= Track). If you activate the soft menu key FRAME TIME DIFFERENCE (highlighted in blue), the time difference to the previous frame (data packet) will be displayed in the BUS table. This column will be labeled in the table as TIME DIFF. If this function is deactivated, the absolute time in relation to the trigger point will be displayed in the column START TIME. The soft menu key TAB in the BUS short menu allows you to activate or deactivate the BUS table without opening a menu. You can use the soft menu item POSITION to move the table to the top or bottom of the screen. In addition, it is possible to display the BUS table in full screen. Select the position via universal knob in the

BUS menu or directly via soft menu key POS in the BUS short menu.

### 13.3 Parallel / Parallel Clocked BUS

The R&S®HMO1002 resp. R&S®HMO1202 series has a PARALLEL and PARALLEL CLOCKED BUS function installed ex factory and is able to analyze up to 7 bit lines. The soft menu key BUS WIDTH and the universal knob allow you to select the number of bit lines. The soft menu keys PREVIOUS/NEXT BIT allow you to move the position of the selection bar for the source of the individual bits. The selected bit is highlighted in blue. The left side of the table contains the bits in fixed sequence, beginning at the top with D0 (= LSB). The universal knob allows you to assign a real logic channel to the selected BUS bit. The allocation is not subject to restrictions; you can also use partially identical logic channels in the two possible buses.

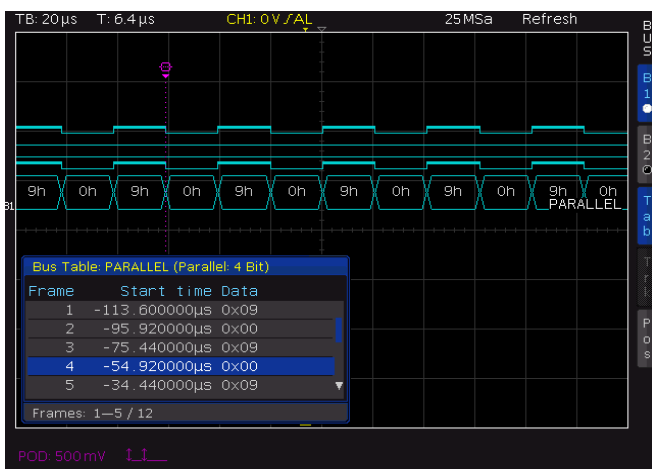

Fig. 13.3: Example PARALLEL BUS with BUS table

If you select PARALLEL CLOCKED as BUS TYPE, you can also use the bottom soft menu key CONTROL WIRES to select sources for CHIP SELECT, and you can use the universal knob to select the settings for CLOCK. The soft menu key ACTIVE is used to determine if the chip select signal High or Low Active is selected. The soft menu key SLOPE allows you to toggle between rising, falling and both slopes. The active selection is always highlighted in blue and is listed after the label CLK in the bit source window. Press the MENU OFF button to return to the BUS main menu.

Column	Description
Start Time	Time of frame start in relation to the trigger point
Data	Values of the data bytes

Tab. 13.1: Content of the PARALLEL BUS table

To trigger on parallel buses, it is recommended to use the logic trigger (see chapter 6.3.3).

### 13.4 I<sup>2</sup>C BUS

For I<sup>2</sup>C BUS trigger and decoding you need the R&S®H0010 resp. R&S®H0011 option or the upgrade voucher R&S®HV110 resp. R&S®HV111.

The I<sup>2</sup>C BUS is a two-wire bus which was developed by Philips (today known as NXP Semiconductor). A I<sup>2</sup>C BUS has the following properties:

- Two wire bus (2-wire): Clock (SCL) and data (SDA)
- Master-Slave Communication: the master provides the clock pulse and selects the slave
- Addressing: Each slave can be addressed via unique address; multiple slaves can be linked with each other and can be addressed by the same master
- Read/Write bit: Master reads data (=1) or writes data (=0)
- Acknowledge: issued after each byte

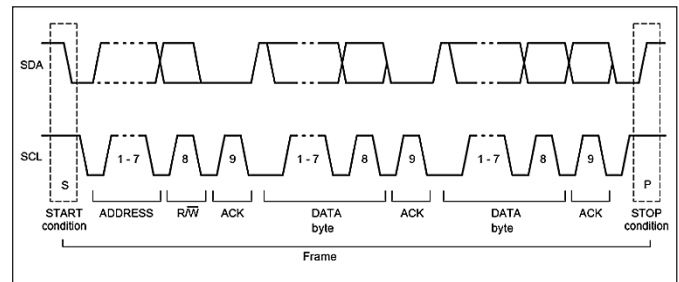

Fig. 13.4: I<sup>2</sup>C 7-Bit-Address

The format of a simple I<sup>2</sup>C message (frame) with an address length of 7 bit is structured as follows:

- **Start condition:** Falling slope on SDA (Serial Data), while SCL (Serial Clock) is HIGH
- **7 bit address** (write or read slave)
- **Read/Write bit (R/W):** Indicates, if the data is to be written or read out from the slave
- **Acknowledge bit (ACK):** Is issued by the recipient of the previous byte if transmission was successful (exception: for read access, the master terminates the data transmission with a NACK bit after the last byte)
- **Data:** a series of data bytes with a ACK bit after each byte
- **Stop condition:** rising slope on SDA (Serial Data), while SCL (Serial Clock) is HIGH

#### 13.4.1 I<sup>2</sup>C BUS Configuration

Prior to the BUS configuration it is necessary to set the correct logic level (threshold). Please refer to chapter 4.5. The default setting is 500 mV.

To decode the I<sup>2</sup>C BUS it is necessary to determine during the bus configuration which logic channel will be connected to the clock (SCL) and which one to the data line (SDA). This setting is selected after choosing the BUS TYPE I<sup>2</sup>C in the BUS menu and pressing the soft menu key CONFIGURATION. In the menu, choose the top soft menu key CLOCK SCL and use the universal knob in the CURSOR/MENU section to select the source channel. You can define the data channel by pressing the soft menu key DATA SDA. With the soft menu key 7BIT ADRESS you can choose, if the adress should be interpreted inclusive (ADR.+RW) or without Read/Write bit (ADDR. ONLY). A small window provides information about the current settings. Press the MENU OFF button twice to close all menus.



If the option R&S®H0011 resp. the voucher R&S®HV111 is installed, it is only possible to select analog channels as source. If the option R&S®H0010 resp. the voucher R&S®HV110 is installed, both analog and digital channels are available as source.

Certain portions of the I<sup>2</sup>C messages will be displayed in color to distinguish between the different elements. If the data lines are selected with the table display, the respective sections will also be displayed in color. These are described as follows:

- Read address: Yellow
- Write address: Magenta
- Data: Cyan
- Start: White
- Stop: White
- No acknowledge: Red
- Acknowledge: Green

### 13.4.2 I<sup>2</sup>C Bus Triggering

After the BUS configuration, it will be possible to trigger on various events. Press the TYPE button in the TRIGGER section and choose the soft menu key SERIAL BUSES. Then press the SOURCE button in the TRIGGER section and choose I<sup>2</sup>C Bus. This will only be available if it was configured earlier. Press the FILTER button in the TRIGGER section to list all available I<sup>2</sup>C trigger conditions.

Following trigger conditions can be defined:

- **START:** The oscilloscope triggers on the frame start sequence. The start sequence is the falling slope on SDA when SCL is high.
- **STOP:** The oscilloscope triggers on the frame stop sequence. The start signal is the rising slope on SDA when SCL is high.
- **RESTART:** The oscilloscope triggers, if a new start sequence occurs before the stop condition. The new start signal is a repeated start signal.
- **NOT-ACKNOWLEDGE:** The NOT-ACKNOWLEDGE bit is the 9th bit in a data or address unit of the SDA line. For NOT-ACKNOWLEDGE, the Acknowledge bit is on SDA high, although it should be low.
- **READ/WRITE:** The soft menu key READ/WRITE offers additional trigger options. You can use the soft menu key MASTER to toggle the trigger condition between read and write access. The 8th bit of the first data unit (depending on the address length) is used to distinguish between read and write access. The selected condition is displayed in the I<sup>2</sup>C settings window and is highlighted by the menu key in blue. The address length (in bit) defines the maximum number of slave addresses to be used with the bus. For a 7 bit address length, the maximum number of available addresses is 112. The 10 bit addressing mode is downward compatible with the 7 bit addressing mode by using 4 of 16 reserved addresses and can be used simultaneously. For a 10 bit address length, a total of 1136 addresses (1024 + 128 - 16) is available. The highest 10 bit address is 1023 (0x3FF). The selected address length is displayed in the I<sup>2</sup>C settings window and is highlighted by the menu key in blue. The SLAVE ADDRESS is the address used on the BUS to distinguish which slave

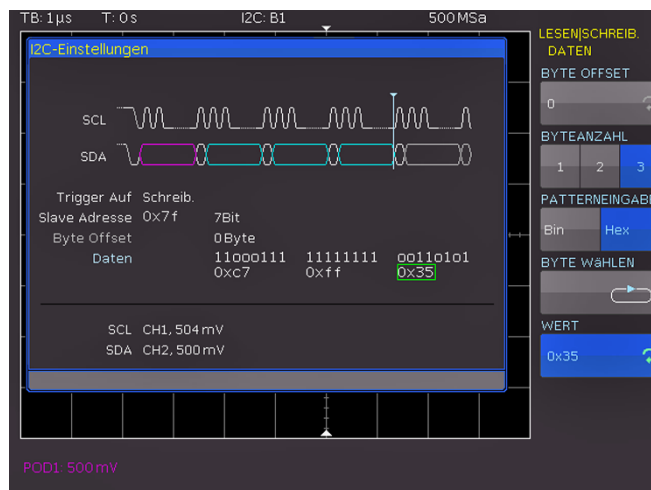

Fig. 13.5: I<sup>2</sup>C Read/Write trigger menu

the master communicates with. Use the universal knob in the CURSOR/MENU section to select the address for the observing bus participant to be triggered. The soft menu DATA enables you to enter specific data in addition to the address. With this menu, you can trigger on clearly defined data bytes (color cyan) within the transmission, allowing you to filter out irrelevant transmissions. You can trigger on up to 24 bit (3 byte) of data. An offset of 0 to 4095 to the address is allowed. Select BYTE OFFSET which defines the distance between the bytes relevant for the trigger condition and the address. In most cases, the byte offset is zero if the trigger is to occur on the maximum first 24 bits after the address. The soft menu key NUMBER OF BYTES allows you to define how many bytes are to be analyzed for the trigger condition. The input may be binary or hexadecimal (PATTERN INPUT). If binary input is selected, the individual bits can be assigned to any condition via soft menu key SELECT BIT and the universal knob. The soft menu key STATE allows you to set the state H (=1), L (=0) or X (don't care) for each bit. The state X defines any state. If the input is hexadecimal, only the entire byte can be set to X. If you choose the hexadecimal input, use the soft menu key VALUE and the universal knob to set the respective byte value. The soft menu key SELECT BYTE allows you to edit the different bytes (byte 1 to byte 2 to byte 3 etc.)

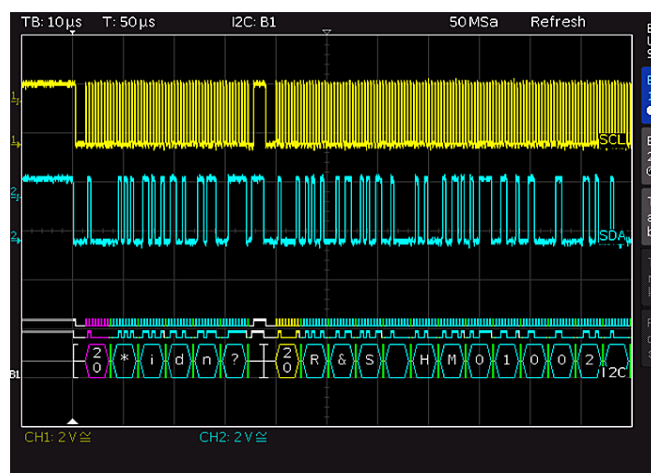

Fig. 13.6: I<sup>2</sup>C BUS

sequentially (depending on the defined NUMBER OF BYTES). The active byte will be marked with a green border in the display window of the trigger condition (see fig. 12.9).

Press the MENU OFF button three times to close all menus, and the oscilloscope will trigger on the set address and data. For measurements without measuring object please refer to chapter 10.2.5.

### 13.4.3 I<sup>2</sup>C BUS Table

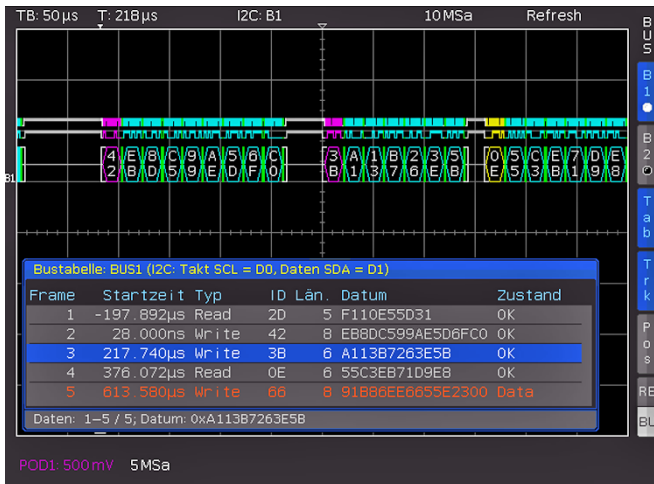

Fig. 13.7: I<sup>2</sup>C BUS Table

Column	Description
Start Time	Time of frame start in relation to the trigger point
Type	Value of the R/W bit (Read/Write)
ID	Value of the address
Length	Number of words in the frame
Data	Values of the data words
State	Frame State: <ul style="list-style-type: none"> <li>■ OK = Frame is valid</li> <li>■ DATA = during acquisition start/end only te frame start / frame end has been decoded; currently no data available</li> <li>■ ADDR. ERR. = incomplete frame decoding</li> <li>■ INS = the frame is not completely contained in the acquisition; the acquired part of the frame is valid.</li> </ul>

Tab. 13.2: Content of the I<sup>2</sup>C BUS Table

### 13.5 SPI / SSPI BUS

**For SPI/SSPI BUS trigger and decoding you need the R&S®H0010 resp. R&S®H0011 option or the upgrade voucher R&S®HV110 resp. R&S®HV111.**

The Serial Peripheral Interface SPI is used to communicate with slow peripheral devices, in particular for the transfer of data streams. The SPI bus was developed by Motorola (today known as Freescale); however, it has not been formally standardized. Generally, this is a bus with clock and data lines and a select line (3-wire). If only one master and one slave are present, the select line may be deleted. This type of line is also called SSPI (Simple SPI) (2-wire). A SPI BUS has the following properties:

- Master-slave communication
- No instrument addressing

- No acknowledge to confirm data reception
- Duplex capability

Most SPI buses have 4 common lines, 2 data lines and 2 control lines:

- Clock to all slaves (SCLK)
- Slave select or chip select lines (SS or CS)
- Master-Out-Slave-In, Slave-Data-Input (MOSI or SDI)
- Master-In-Slave-Out, Slave-Data-Output (MISO or SDO)

If the master generates a clock pulse and selects a slave, data can be transmitted in either one direction or simultaneously in both directions (only available with R&S®H0010/R&S®HV110).

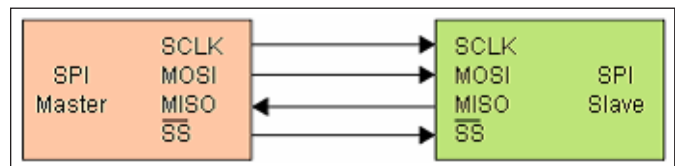

Fig. 13.8: Simple configuration of SPI BUS

### 13.5.1 SPI / SSPI BUS Configuration

**Prior to the BUS configuration it is necessary to set the correct logic level (threshold). Please refer to chapter 4.5. The default setting is 500 mV. For 3-wire SPI the external trigger input will be used a CS (Chip Select). The threshold can be set in the BUS configuration menu.**

Certain settings are necessary to guarantee that a SPI bus is decoded correctly. First, you have to determine if a SPI system with or without chip select is available (2-wire or 3-wire SPI). This can be done in the BUS setup menu when selecting the BUS type. For a 2-wire SPI system, select the option SSPI; for a 3-wire SPI system, select the option SPI. Then press the CONFIGURATION button to open the setup menu for SPI. Use the top soft menu key SOURCE to select the respective channel for chip select (CS), clock (Clk) and data. Select the respective soft menu key CS, Clk or Data and then use the soft menu key DATA and the universal knob to select the respective source channel. For the 2-wire SPI, select the possible TIME OUT instead of a chip select source. During the time out, data and clock line are at Low. When the time out has been reached, a new frame begins. If the time intervals between the data packets are shorter than the time out, these packets belong to the same frame. You can select the dead time via universal knob or via numeric input (KEYPAD button). A small window provides information about the current settings.

**If the option R&S®H0011 resp. the voucher R&S®HV111 is installed, it is only possible to select analog channels as source. If the option R&S®H0010 resp. the voucher R&S®HV110 is installed, both analog and digital channels are available as source.**

In addition to assigning the source, the soft menu key ACTIVE allows you to select the following settings:

- CS: Chip select high or low active (low active is the default setting)

- **CLK:** Data will be stored with rising or falling slope (rising slope is the default setting)
- **DATA:** Data high or low active (high active is the default setting)

Certain portions of the SPI/SSPI messages will be displayed in color to distinguish between the different elements:

- **White:** Start / End of complete frame
- **Red:** Incomplete word that is not completely contained in the acquisition; change the horizontal scale or move the "Time Reference" to get a longer acquisition
- **Cyan:** Decoded words

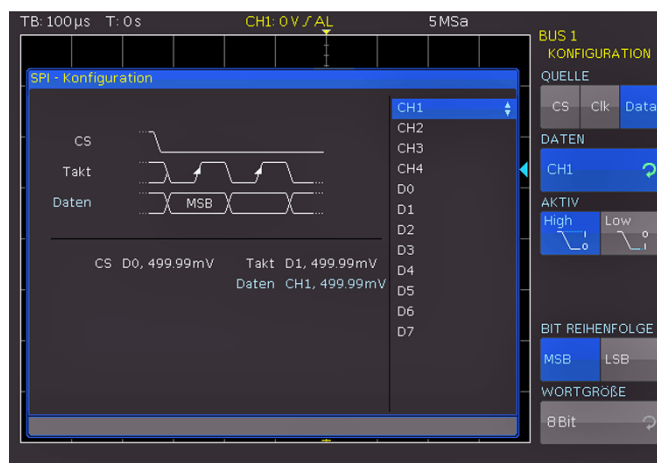

Fig. 13.9: Menu for the definition of a SPI bus

You can use the soft menu key BIT ORDER to determine if the data of each message starts with the MSB (most significant bit) or the LSB (least significant bit). The soft menu key WORD SIZE allows you to select via universal knob how many bits are included per message. You may select any value between 1 and 32 bits.

### 13.5.2 SPI / SSPI BUS Triggering

After the SPI/SSPI BUS configuration, it will be possible to trigger on various events. Press the TYPE button in the TRIGGER section of the control panel and choose the soft menu key SERIAL BUSES. Then press the SOURCE button in the TRIGGER section and choose SPI Bus. This will only be available if it was configured earlier. Press the FILTER button in the TRIGGER section of the control panel to list all available SPI trigger conditions. The following trigger conditions can be defined:

- **FRAME START:** Sets the trigger event on the start of the frame. The frame starts when the chip select (CS) signal switches to the selected active mode.
- **FRAME END:** Sets the trigger event on the end of the frame. The frame ends when the chip select (CS) signal switches from the selected active to the inactive mode.
- **BIT:** Selects the trigger time to the set bit within the set bit sequence with the universal knob in the CURSOR/MENU section. You can also enter a numeric value to determine the desired bit number (KEYPAD button).
- **SER. PATTERN:** Use the soft menu SER. PATTERN to define a specific bit sequence within the frame which start the trigger event. The soft menu key BIT OFFSET

allows you to select the first bit of the predefined bit sequence within the frame. The bits in front of it have no impact on the trigger event (for instance, if the bit offset = 2, bit 0 and bit 1 after CS will be ignored and the pattern begins with bit 2). You can select a value between 0 and 4095 via universal knob or enter it numerically (KEYPAD button). The soft menu key NUMBER OF BITS allows you to select how many bits will be analyzed for the trigger condition. You can select a value between 1 and 32 bit via universal knob. The serial bit sequence (PATTERN INPUT) can be entered as binary or hexadecimal value. If you choose the binary input, the soft menu key SELECT BIT and the universal knob allow you to select which individual bits within the data are to be edited. The option STATE allows you to assign a logic state to each bit (High = H = 1, Low = L = 0 or X = don't care). The state X defines any state. If you choose the hexadecimal input, the soft menu key VALUE and the universal knob allow you to set the value for the respective nibble (4 bit). If the input is hexadecimal, only the entire nibble can be set to X. Use the soft menu key SELECT NIBBLE to toggle between nibbles. The active nibble will be marked with a green border in the display window of the trigger condition.

Press the MENU OFF button three times to close all menus, and the oscilloscope will trigger on the set bit sequence. For measurements without measuring object please refer to chapter 10.2.5.

### 13.5.3 SPI/SSPI BUS Table

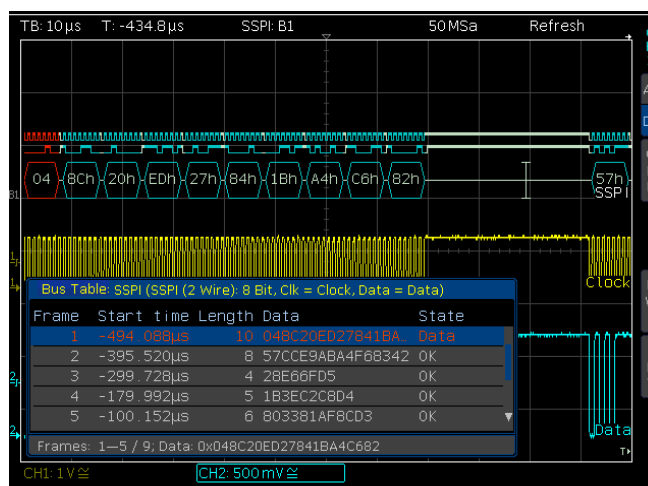

Fig. 13.10: Example SSPI BUS table

Column	Description
<b>Start Time</b>	Time of frame start in relation to the trigger point
<b>Length</b>	Number of words in the frame
<b>Data</b>	Values of the data words
<b>State</b>	Frame Status: <ul style="list-style-type: none"> <li>■ <b>OK</b> = Frame is valid</li> <li>■ <b>DATA</b> = during acquisition start/end only the frame start / frame end has been decoded; currently no data available</li> <li>■ <b>INS</b> = the frame is not completely contained in the acquisition; the acquired part of the frame is valid.</li> </ul>

Tab. 13.3: Content of the SPI/SSPI BUS table

### 13.6 UART/RS-232 BUS

**For UART/RS-232 BUS trigger and decoding you need the R&S®H0010 resp. R&S®H0011 option or the upgrade voucher R&S®HV110 resp. R&S®HV111.**

The UART bus (Universal Asynchronous Receiver Transmitter) is a general bus system and the base for many protocols. One example is the RS-232 protocol. It consists of a frame with a start bit, 5 to 9 data bits, one parity bit and a stop bit. The stop bit can assume the single length, or 1.5 or twice the length of a normal bit.

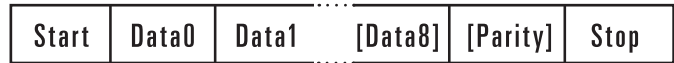

Fig. 13.11: UART bit sequence

#### 13.6.1 UART/RS-232 BUS Konfiguration

**Prior to the BUS configuration it is necessary to set the correct logic level (threshold). Please refer to chapter 4.5. The default setting is 500 mV.**

To decode the UART BUS it is necessary to first determine which channel will be connected to the data line. This setting is selected after choosing the bus type UART in the BUS menu and pressing the soft menu key CONFIGURATION. In the menu that opens you can press the top soft menu key DATA SOURCE to select the desired channel via universal knob.

**If the option R&S®H0011 resp. the voucher R&S®HV111 is installed, it is only possible to select analog channels as source. If the option R&S®H0010 resp. the voucher R&S®HV110 is installed, both analog and digital channels are available as source.**

The soft menu key ACTIVE can be used to determine if the data transferred to the BUS are active high (High = 1) or active low (Low = 1) (for RS-232, choose Low). Use the soft menu key SYMBOL SIZE and the universal knob to select a value between 5 bit to 9 bit for the bits that form a symbol. Another setting can be selected via soft menu key PARITY. Parity bits are used to detect errors during a transmission. The soft menu PARITY offers the following options:

- **None:** Use no parity bits
- **Even:** The parity bit is set to "1" if the number of ones in a specific set of bits is uneven (without parity bit)
- **Odd:** The parity bit is set to "1" if the number of ones in a specific set of bits is even (without parity bit)

The bottom soft menu key STOP BITS allows you to define the length of the stop bit (1 = single, 1.5 = 1 1/2 or 2 = double). On page 2|2 of the UART BUS setup menu, you can select the BIT RATE (symbol rate) via universal knob in the CURSOR/MENU section. The bit rate defines how many bits are sent per second. The soft menu key BIT RATE allows you to select standard numeric values. Press the soft menu key USER if you wish to define customized rates via universal knob or numeric input (KEYPAD button). The IDLE TIME describes the minimum time between the stop bit of the last data and the start bit of the new data. The sole purpose of the idle time is to define the start of a transmission and consequently the exact start of a frame (one or more symbols, most commonly bytes). Only this information can guarantee correct decoding and triggering (regardless of the trigger type). A start bit within the idle time will not be recognized. You can enter the value via universal knob in the CURSOR/MENU section or numeric input (KEYPAD button).

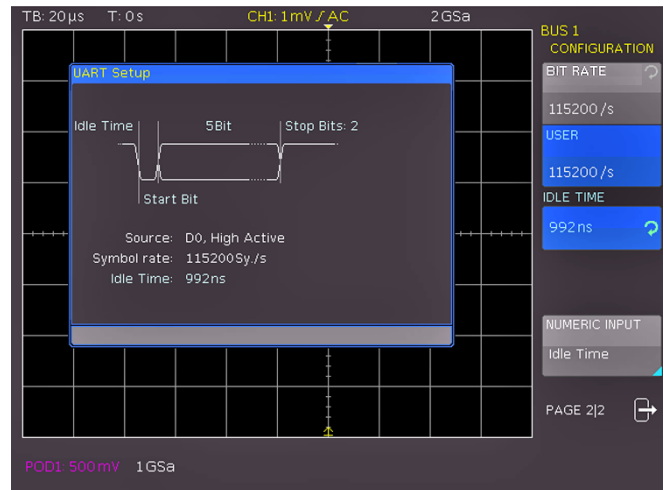

Fig. 13.13: Page 2|2 UART BUS setup menu

Certain portions of the UART messages will be displayed in color to distinguish between the different elements:

- **White:** Start / End of complete frame
- **Red:** Incomplete word that is not completely contained in the acquisition; change the horizontal scale or move the "Time Reference" to get a longer acquisition
- **Cyan:** Decoded words

#### 13.6.2 UART/RS-232 BUS Triggering

After the BUS configuration, it will be possible to trigger on various events. Press the TYPE button in the TRIGGER section of the control panel and choose the soft menu key SERIAL BUSES. Then press the SOURCE button in the TRIGGER section and choose UART. This will only be available if it was configured earlier.

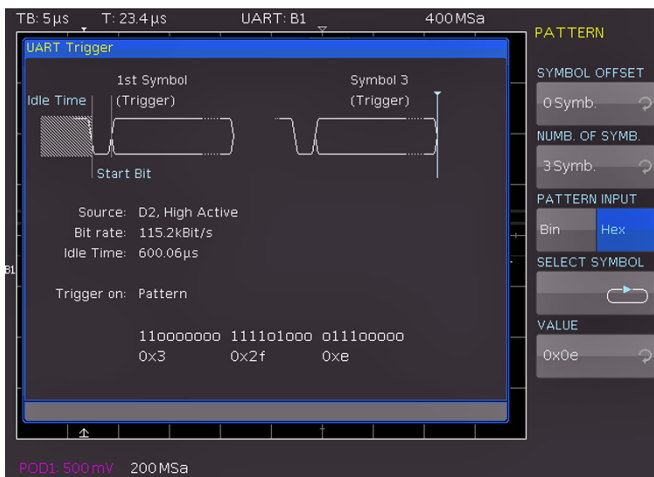

Fig. 13.12: Trigger menu UART data

Press the FILTER button in the TRIGGER section of the control panel to list all available UART trigger conditions:

- **START BIT:** Sets the start bit as trigger event. The start bit is the first 0 bit that succeeds a stop bit or idle time.
- **FRAME START:** Defines the first start bit after idle time.
- **SYMBOL<N>:** Assigns a predefined N-th symbol as trigger event.
- **ANY SYMBOL:** The soft menu ANY SYMBOL allows you to define any symbol to trigger on. The symbol can be located anywhere within a frame. The serial bit sequence (PATTERN INPUT) can be entered as binary or hexadecimal value. If you choose the binary input, the soft menu key SELECT BIT and the universal knob allow you to select which individual bits within the data are to be edited. Select the option STATE to assign a logic state to each bit (High = H = 1, Low = L = 0 or X = don't care). The state X defines any state. If you choose the hexadecimal input, the soft menu key VALUE and the universal knob allow you to set the value for the respective symbol. If the input is hexadecimal, only the entire symbol can be set to X. Use the soft menu key SELECT SYMBOL to toggle between symbols.
- **PATTERN:** Offers additional options for UART trigger settings. The soft menu key SYMBOL OFFSET and the universal knob are used to select the number of irrelevant symbols that proceed the pattern within the frame that are relevant for the trigger event. Any value between 0 to 4095 symbols after the start bit may be entered. Use the soft menu key NUMB. OF SYMB. to select the number of relevant symbols as 1, 2 or 3. The number of symbol defines the pattern size. The symbol length (5 to 9 bit) was configured at the time of the bus definition and will be observed accordingly in the trigger menu. The value input for the symbols may be binary or hexadecimal (as described above). Use the soft menu key PATTERN INPUT for this selection. If binary input is selected, the individual bits can be assigned via soft menu key SELECT BIT and the universal knob. The soft menu key STATE allows you to determine the state for each bit (1, 0 or X). If you choose the hexadecimal input, the soft menu key VALUE and the universal knob allow you to set the value for the respective symbol. Use the soft menu key SELECT SYMBOL to toggle between symbols. The active byte will

be marked with a green border in the display window of the trigger condition.

- **PARITY ERROR:** Trigger with a parity filter
- **FRAME ERROR:** Trigger with a frame error
- **BREAK:** Trigger with a break. The BREAK condition is fulfilled if a stop bit does not succeed a start bit within a specified time period. The stop bits low are active during the break.

Press the MENU OFF button three times to close all menus, and the oscilloscope will trigger on the set bit sequence. For measurements without measuring object please refer to chapter 10.2.5.

### 13.6.3 UART BUS Table

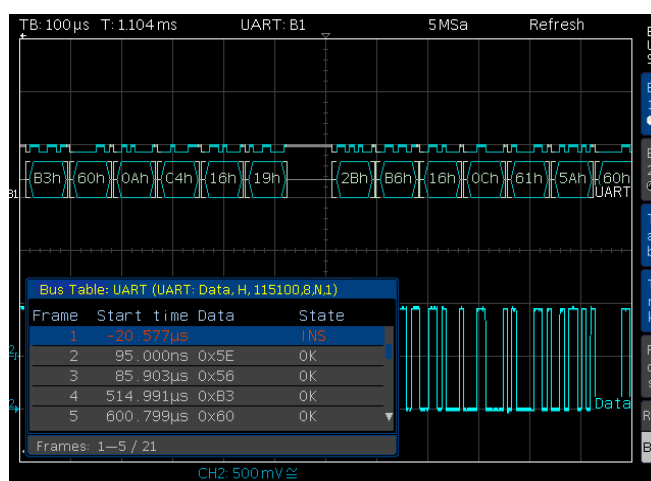

Fig. 13.15: Example UART BUS table

Column	Description
<b>Start Time</b>	Time of frame start in relation to the trigger point
<b>Data</b>	Values of the data words
<b>State</b>	Frame State: <ul style="list-style-type: none"> <li>■ <b>OK</b> = Frame is valid</li> <li>■ <b>DATA</b> = during acquisition start/end only the frame start / frame end has been decoded; currently no data available</li> <li>■ <b>INS</b> = the frame is not completely contained in the acquisition; the acquired part of the frame is valid.</li> </ul>

Tab. 13.4: Content of the UART BUS table

## 13.7 CAN BUS

**For CAN BUS trigger and decoding you need the R&S®H0012 option or the upgrade voucher R&S®HV112.**

The CAN bus (Controller Area Network) is a bus system primarily developed for automotive applications and is used for the data exchange between controller units and sensors. It can be found increasingly in the aviation, healthcare, and general automation industries. At the physical level, CAN is a differential signal, therefore a differential probe (e.g. HZO40) is recommended for decoding, although standard probes are equally suitable to capture the signals. The standard data rates range between 10 kBit/s and 1 MBit/s. A CAN message primarily consists of a start bit, the Frame ID (11 or 29 bit), the data length code DLC, the data, a CRC, acknowledge and an end bit.

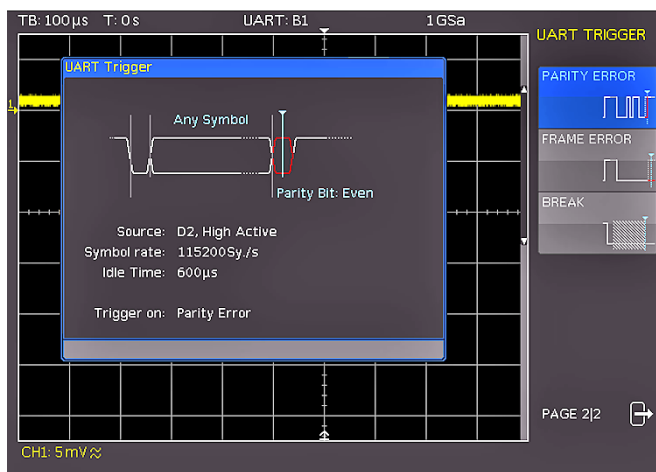

Fig. 13.14: UART trigger menu page 2

### 13.7.1 CAN BUS Configuration

**Prior to the BUS configuration it is necessary to set the correct logic level (threshold). Please refer to chapter 4.5. The default setting is 500 mV.**

After choosing the BUS type CAN in the BUS menu the configuration menu will open after pressing the soft menu key CONFIGURATION. In the menu that opens you can press the top soft menu key DATA to select the desired channel via universal knob in the CURSOR/MENU section. An analog or a digital channel can be connected to CAN-High or CAN-Low. In addition, it is possible to connect a differential probe (e.g. HZO40) to an analog channel. When using a differential probe, select CAN High if the positive input of the probe is connected to CAN-H and the negative input to CAN L. If the probe is connected with reversed polarity, you must select CAN L.

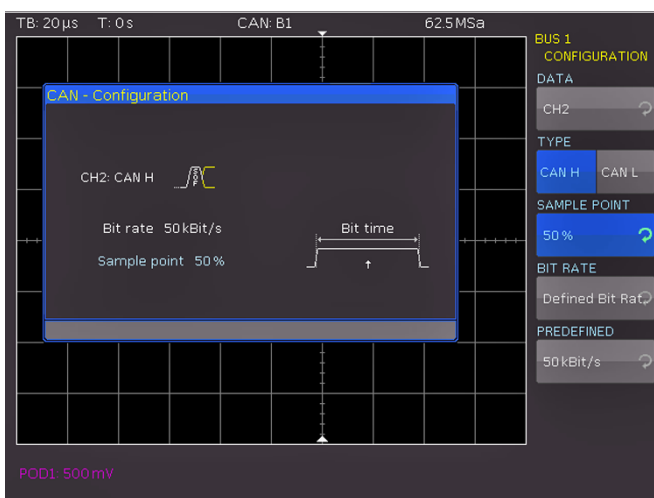

Fig. 13.16: CAN BUS configuration

The soft menu key SAMPLE POINT allows you to specify the exact point within the bit at which the value for the current bit is sampled. You can select a value in percent (25% to 90%) via universal knob or KEYPAD key in the CURSOR/MENU section. The option BIT RATE defines how many bits are transmitted per second and allows you to select default data rates via universal knob. Use the soft menu key USER to specify user-defined bit rates. You can enter the value via universal knob or numeric input (KEY-PAD button).

Certain portions of the UART messages will be displayed in color to distinguish between the different elements:

- **Weiß:** Data length code, number of data bytes
- **Cyan:** Data words
- **Magenta:** Identifier
- **Rot:** Frame Error

### 13.7.2 CAN BUS Triggering

After the CAN BUS configuration, it will be possible to trigger on various events. Press the TYPE button in the TRIGGER section and choose the soft menu key SERIAL BUSES. Then press the SOURCE button in the TRIGGER section and choose CAN. This will only be available if it was configured earlier. Press the FILTER button in the TRIGGER section to

list all available CAN trigger conditions:

- **START OF FRAME:** Triggers on the first slope of the SOF bit (synchronizing bit).
- **END OF FRAME:** Triggers on the end of the frame.
- **FRAME:** The submenu offers different options, like trigger on ERROR (general frame error), OVERLOAD (trigger on CAN Overload frames) or DATA (trigger on data frames). With the soft menu key READ/DATA you are able to trigger on read and data frames. With the soft menu key IP TYPE the identifier type (11 bit, 29 bit or any.) can be selected.
- **ERROR S:** Identifies various errors in a frame. This menu allows you to choose one or several error message types as trigger condition. Individual frame segments (e.g. frame start etc.) are coded during the bit stuffing procedure. The transmitter automatically adds a complimentary bit to the bit stream if it detects 5 consecutive bits with identical value in the bit stream to be transmitted. A "STUFF" error occurs if the 6th identical bit level is detected in the specified sections. A FORM error occurs if a fixed bit field contains one or several invalid bits. An authentication error occurs if the transmitter receives no authentication (acknowledge). CAN BUS applies a complex checksum calculation (Cyclic Redundancy Check). The transmitter calculates the CRC and transmits the result in a CRC sequence. The receiver calculates the CRC in the same manner. A CRC error occurs if the calculated result deviates from the received CRC sequence.
- **IDENTIFIER:** Identifies the priority and the logical address of a message. In the menu that opens you can press the top soft menu key to select the FRAME TYPE (general data, read data or read/write data) via universal knob. The soft menu IDENTIFIER SETUP below allows you to specify the length of the identifier type via soft menu key ID TYPE and universal knob (11 bit base or 29 bits for extended CAN frames). The soft menu key COMPARE defines the comparison function. If the pattern includes at least one X (don't care), it is possible to trigger on a value equal or not equal to the specified value. If the pattern includes only 0 or 1, it is possible to trigger on an area greater than or less than the specified value. The PATTERN INPUT may be binary or hexadecimal. If you choose the binary input, the soft menu key BIT and the universal knob allow you to

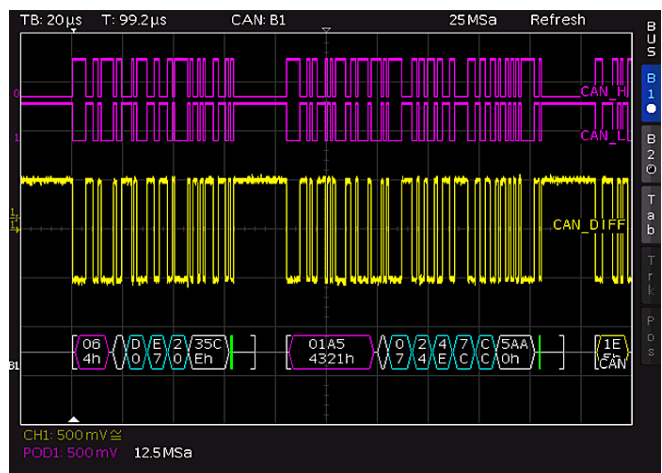

Fig. 13.17: CAN BUS

select which individual bits within the data are to be edited. Select the option STATE to assign a logic state to each bit (High = H = 1, Low = L = 0 or X = don't care). The state X defines any state. If you choose the hexadecimal input, the soft menu key VALUE and the universal knob allow you to set the value for the respective byte. If the input is hexadecimal, only the entire byte can be set to X. Use the soft menu key BYTE to toggle between bytes.

**IDENTIFIER AND DATA:** Includes the same settings as the soft menu IDENTIFIER. In the menu that opens you can select the FRAME TYPE (general data or read data) via top soft menu key and universal knob. In the menu IDENTIFIER SETUP below you can enter the address of the respective pattern. The soft menu DATA SETUP allows you to specify the data bit pattern or HEX values for up to 8 bytes (only available if DATA was selected as frame type). Available comparisons for address and data values are GREATER, EQUAL OR LESS, EQUAL and NOT EQUAL.

Press the MENU OFF button twice or three times to close all menus, and the oscilloscope will trigger on the set data. For measurements without measuring object please refer to chapter 10.2.5.

### 13.7.3 CAN BUS Table

Column	Description
<b>Start Time</b>	Time of frame start in relation to the trigger point
<b>Type</b>	Frame Type: <ul style="list-style-type: none"> <li>■ <b>DATA</b> = Data Frame</li> <li>■ <b>REMOTE</b> = Remote Frame</li> <li>■ <b>ERR-F.</b> = Transmission error (Error Frame)</li> <li>■ <b>OVL-F.</b> = Overload Frame</li> </ul>
<b>ID</b>	Frame ID
<b>DLC</b>	Data length code, number of data bytes
<b>Data</b>	Values of the data bytes
<b>CRC</b>	Cyclic Redundancy Check
<b>State</b>	Frame State: <ul style="list-style-type: none"> <li>■ <b>OK</b> = Frame is valid</li> <li>■ <b>CRC</b> = the calculated result deviates from the received CRC sequence (cyclic redundancy check failed)</li> <li>■ <b>NACK</b> = not Acknowledge</li> <li>■ <b>CRC+NACK</b> = cyclic redundancy check failed followed by „not Acknowledge“</li> <li>■ <b>STUFF</b> = Bit Stuffing Error</li> <li>■ <b>INS</b> = the frame is not completely contained in the acquisition; the acquired part of the frame is valid.</li> </ul>

Tab. 13.5: Content of the CAN BUS table

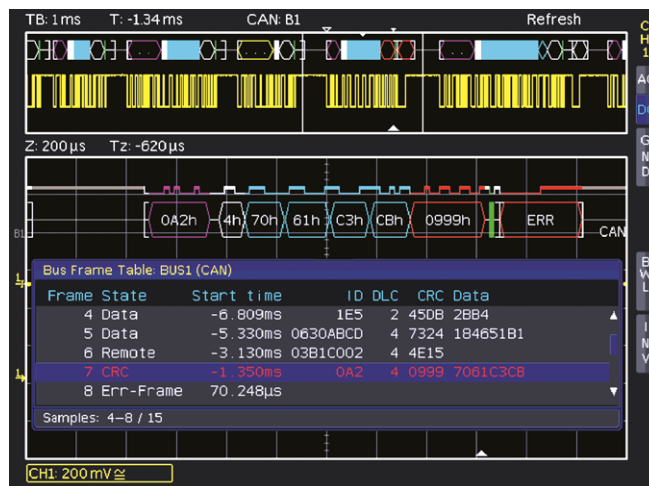

Fig. 13.18: Example CAN BUS table

### 13.8 LIN BUS

**For CAN BUS trigger and decoding you need the R&S®H0012 option or the upgrade voucher R&S®HV112.**

The LIN bus (Local Interconnect Network) is a simple master/slave bus system for automotive applications and is used for the data exchange between controller units and sensors or actuators. The signal is transmitted on one line with ground reference to the vehicle mass. A LIN BUS has the following properties:

- Serial single-wire communication protocol (byte-oriented)
- Master-slave communication (generally up to 12 knots)
- Master-controlled communication (master initiates / coordinates communication)

The data is transmitted in bytes without parity (based on UART). Each byte consists of a start bit, 8 data bits and a stop bit.

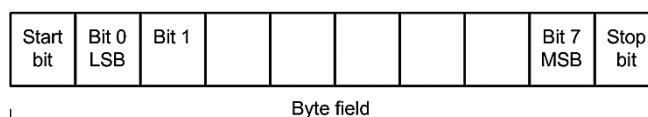

Fig. 13.19: LIN byte structure

#### 13.8.1 LIN BUS Configuration

**Prior to the BUS configuration it is necessary to set the correct logic level (threshold). Please refer to chapter 4.5. The default setting is 500 mV.**

After choosing the BUS type LIN in the BUS menu press the soft menu key CONFIGURATION. In the menu that opens you can press the top soft menu key DATA to select the desired channel via universal knob in the CURSOR/MENU section. The soft menu key POLARITY allows you to toggle between High and Low; the active function will be highlighted in blue. An analog or a digital channel can be connected to LIN-High or LIN-Low. You can select any version for the LIN standard (version 1x, version 2x, J2602 or any) via soft menu key VERSION and universal knob. The option BIT RATE allows you to specify the number of transmitted bits per second. You can use the univer-

sal knob to choose from predefined standard data rates and user-defined data rates (USER). The highest possible user-defined data rate is 4MBit/s. You can enter the user-defined value via universal knob or numeric input (KEYPAD button).

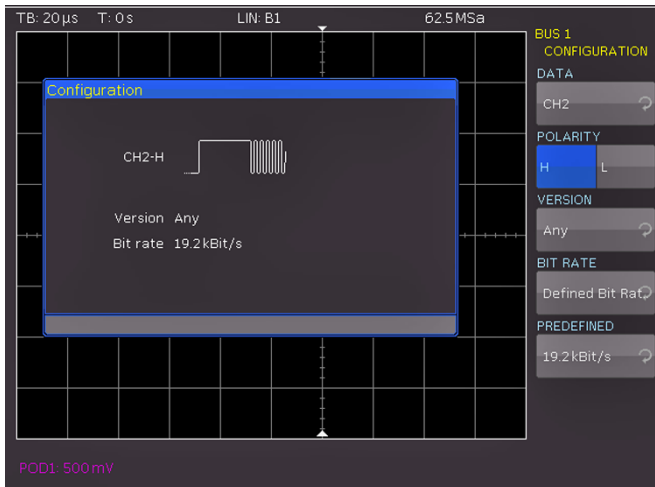

Fig. 13.20: LIN BUS menu

Certain portions of the UART messages will be displayed in color to distinguish between the different elements:

- **White:** Synchronization byte / correct checksum
- **Cyan:** Data words
- **Yellow:** Identifier
- **Green:** Parity bit
- **Red:** Frame Error

### 13.8.2 LIN BUS Triggering

After the BUS configuration, it will be possible to trigger on various events. Press the TYPE button in the TRIGGER section of the control panel and choose the soft menu key SERIAL BUSES. Then press the SOURCE button in the TRIGGER section and choose LIN. This will only be available if it was configured earlier. Press the FILTER button in the TRIGGER section of the control panel to list all available CAN trigger conditions:

- **START OF FRAME:** Triggers on the stop bit of the synchronizing field.
- **WAKE UP:** Triggers after a wake-up frame.
- **ERROR C:** Identifies various errors in a frame. This menu allows you to choose one or several error message types as trigger condition. LIN BUS applies a complex checksum calculation (Cyclic Redundancy Check). The transmitter calculates the CRC and transmits the result in a CRC sequence. The receiver calculates the CRC in the same manner. A CRC error occurs if the calculated result deviates from the received CRC sequence. With soft menu key PARITY triggering occurs on a parity error. Parity bits are bit 6 and bit 7 of the identifier. The correct transfer of the identifier is verified. With the soft menu key SYNCHRONISATION triggering occurs if the synchronizing field indicates an error.
- **ID:** With the soft menu key IDENTIFIER you can set the trigger to a specific identifier or a specific identifier range. The soft menu key COMPARE defines the comparison function. If the pattern includes at least one X (don't care),

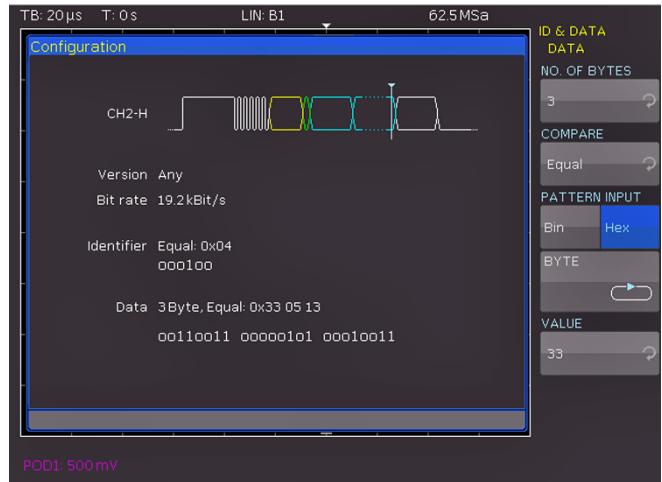

Fig. 13.21: LIN data trigger menu

it is possible to trigger on a value equal or not equal to the specified value. If the pattern includes only 0 or 1, it is possible to trigger on an area greater than or less than the specified value. The PATTERN INPUT may be binary or hexadecimal. If you choose the binary input, the soft menu key BIT and the universal knob allow you to select which individual bits within the data are to be edited. Select the option STATE to assign a logic state to each bit (High = H = 1, Low = L = 0 or X = don't care). The state X defines any state. If you choose the hexadecimal input, the soft menu key VALUE and the universal knob allow you to set the value for the respective byte. If the input is hexadecimal, only the entire byte can be set to X. Use the soft menu key BYTE to toggle between bytes.

- **ID AND DATA:** The soft menu IDENTIFIER AND DATA and the soft menu key IDENTIFIER SETUP include the same settings as the soft menu IDENTIFIER. The soft menu DATA SETUP allows you to specify the data bit pattern or HEX values for up to 8 bytes. Available comparisons for address and data values are EQUAL and NOT EQUAL.

Press the MENU OFF button twice or three times to close all menus, and the oscilloscope will trigger on the set data. For measurements without measuring object please refer to chapter 10.2.5.

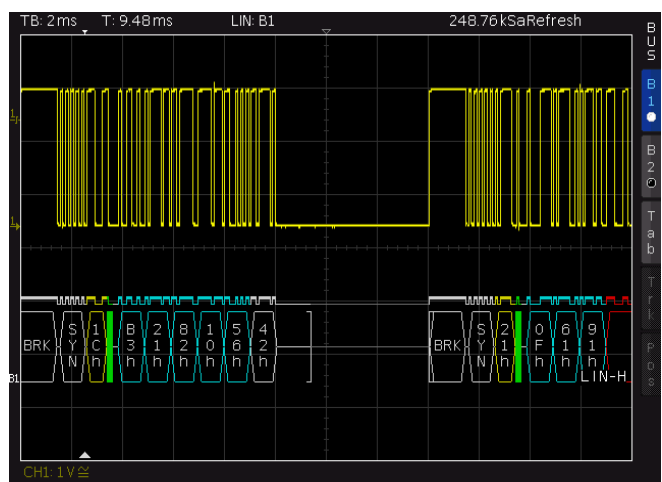

Fig. 13.22: LIN BUS



### 13.8.3 LIN BUS Table

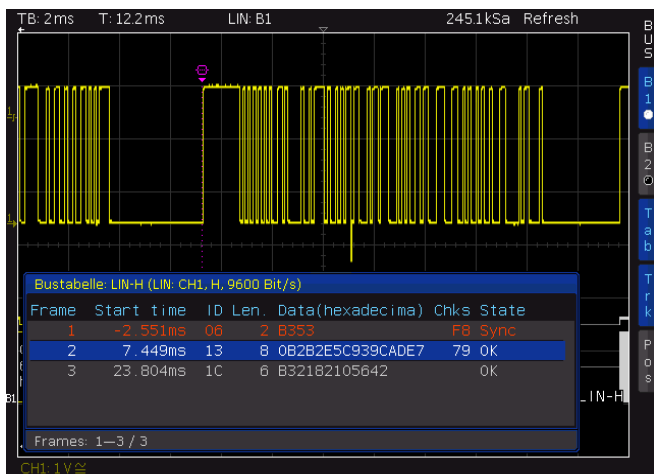

Fig. 13.23: Example LIN BUS table

Column	Description
<b>Start Time</b>	Time of frame start in relation to the trigger point
<b>ID</b>	Frame ID
<b>Length</b>	Number of data bytes
<b>Data</b>	Values of the data bytes
<b>Chks</b>	Checksum value
<b>State</b>	Frame Status: <ul style="list-style-type: none"> <li>■ <b>OK</b> = Frame is valid</li> <li>■ <b>DATA</b> = during acquisition start/end only to frame start / frame end has been decoded; currently no data available</li> <li>■ <b>SYNC</b> = Synchronisation error</li> <li>■ <b>CHKS</b> = Checksum error</li> <li>■ <b>PARI</b> = Parity error</li> <li>■ <b>WAKEUP</b> = WakeUp Frame</li> <li>■ <b>INS</b> = ein „angerissener“ Frame sitzt am Ende der Erfassung und das eigentliche Ende wurde nicht dekodiert</li> </ul>

Tab. 13.6: Content of the LIN BUS table

## 14 Remote Control

The R&S®HMO1002 resp. R&S®HMO1202 series is equipped with a built-in interface card, which have an Ethernet and USB connection on board as a standard.

**To make any communication possible, the chosen interface and it's corresponding settings must be the same in the PC as in the oscilloscope..**

In addition to a LAN interface, the R&S®HMO1002 resp. R&S®HMO1202 series includes a USB device port. For this interface, the user can select if the instrument is accessed via virtual COM port (VCP) or via USB TMC class.

### 14.1 USB VCP

**All currently available USB VCP drivers have been fully tested and released for Windows XP™, VISTA™, Windows 7™ and Windows 8™ (32 + 64 Bit).**

The traditional version of the VCP allows the user to communicate with the measuring instrument using any terminal program via SCPI commands once the corresponding Windows drivers have been installed. The actual USB-VCP driver can be downloaded from the ROHDE & SCHWARZ homepage [www.rohde-schwarz.com](http://www.rohde-schwarz.com) for free. If a connection between PC and the instrument has been established and no R&S®HMO1002 resp. R&S®HMO1202 series USB-VCP driver is installed, the operating system answers with "Found New Hardware". In addition, the "Found New Hardware Wizard" is displayed. Only in this case the USB VCP driver must be installed. Further information about the USB VCP driver installation you can find in the installation guide internal of the driver file.

**The following requirement for USB-VCP driver installation are necessary:**

- 1 R&S®HMO1002 resp. R&S®HMO1202 with an activated USB-VCP interface.**
- 2 A PC with operating system Windows XP™, VISTA™, Windows 7™, Windows 8™ or Windows 10™ (32 or 64Bit).**
- 3 Administrator rights are necessary for the installation of the driver. If an error message regarding spelling errors appears, the rights to install the driver are not given. In this case, please contact your IT department to obtain the necessary rights.**

In addition, you may use the free software HMEexplorer. This Windows application offers the R&S®HMO1002 resp. R&S®HMO1202 series a terminal function, the option to create screenshots and to sort the measured data storage.

### 14.2 USB TMC

A modern alternative to the virtual COM port (VCP) is the control via USB TMC class. TMC stands for „Test & Measurement Class“ which indicates that the connected measurement instrument can be recognized without

## Remote Control

special Windows drivers if VISA drivers are installed and that it can be used directly in corresponding environments. The GPIB interface serves as model to the structure of the TMC design. A major benefit of the USB TMC class is that by sampling specific registers the user can determine if commands have been terminated and if they have been processed correctly. However, the communication via VCP requires analysis and polling mechanisms within the controlling software which may significantly strain the interface of the measurement instruments. The TMC status registers solve this problem with the USB TMC in the same manner as is the case with the GPIB interface for the hardware, namely via corresponding control lines.

**The HMEplorer software does not support the communication via USB TMC.**

### 14.2.1 USB TMC Configuration

The R&S®HMO1002 resp. R&S®HMO1202 series require a generic USB instrument driver to be operated in USB-TMC mode. The USB Test & Measurement class (USB-TMC) is a protocol that enables GPIB-like communication via USB interfaces and a separate instrument class of the USB specification. The USB-TMC protocol supports service requests, trigger and other GPIB-specific commands. The driver is included in the NI-VISA package (Virtual Instrument Software Architecture) and can be downloaded at <http://www.ni.com/downloads/ni-drivers/>.

You need to first install the NI-VISA drivers on your Windows system. Please download the most recent version of the NI-VISA driver package. Extract the previously downloaded driver package and follow the installation instructions.

Below please find an example for NI-VISA 5.4.1:

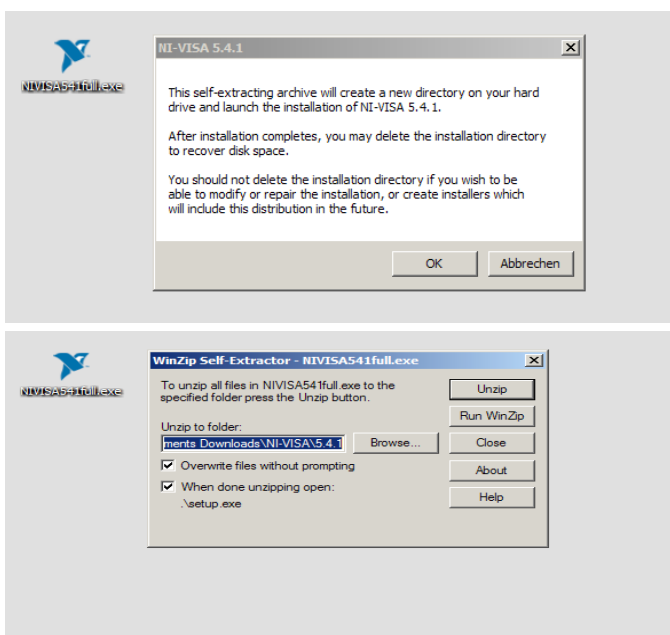

Fig. 14.1: NI-VISA 5.4.1

Select “Next” to start the installation and follow the installation instructions.



Fig. 14.2: NI-VISA installation instructions

In this step, please select “NI-VISA xxx --> Leave this feature and its subfeatures installed locally”.

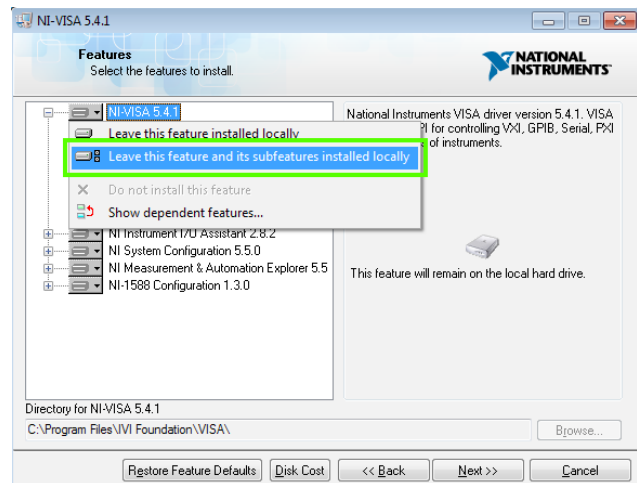

Fig. 14.3: NI-VISA feature installation locally

Now that you have successfully installed the NI-VISA drivers, you can switch your R&S®HMO1002 resp. R&S®HMO1202 to the USB-TMC interface. Select the SETUP menu of your oscilloscope, and choose INTERFACE.

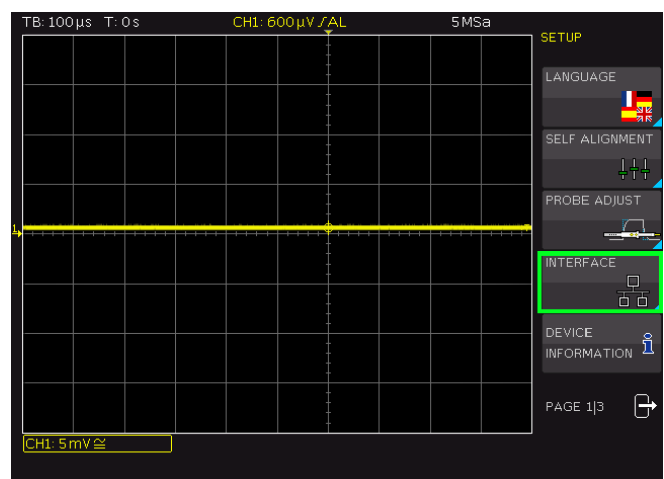

Fig. 14.4: Setup menu

Use the soft key to select “USB” and the soft menu PARAMETER.

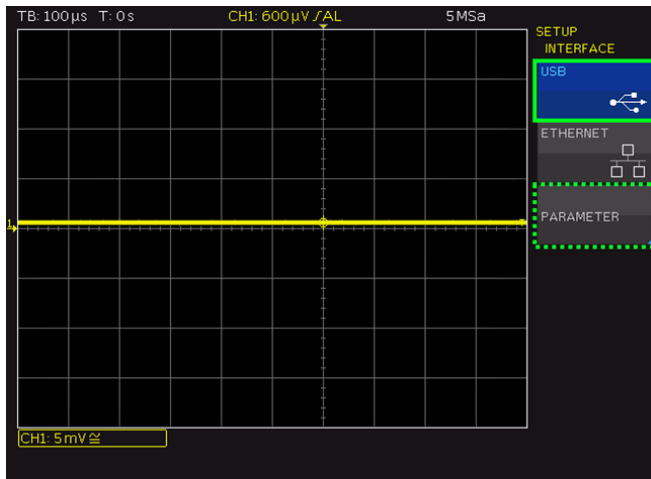

Fig. 14.5: Interface menu

Choose the USB type „USB TMC“.

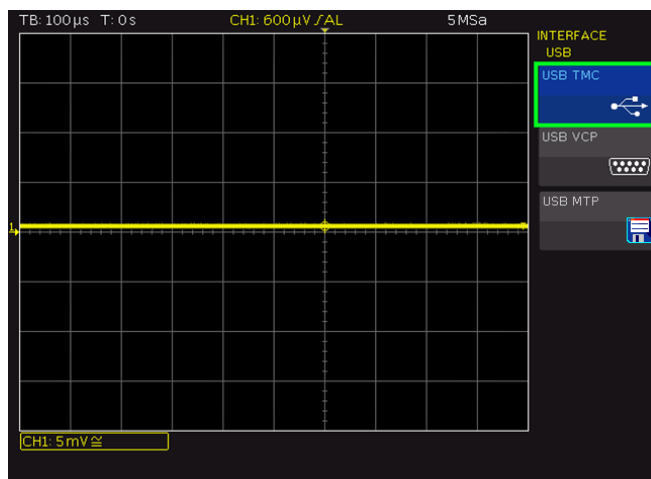

Fig. 14.6: Interface parameter menu

Finally, use a USB interface cable (type A – B) to connect the power supply with your Windows PC. On the first use, the operating system issues the following message: “Found New Hardware”. Once the installation has been successfully completed, the following message will be displayed: “Device Setup” - “USB Test and Measurement Device (IVI), ready to use”.

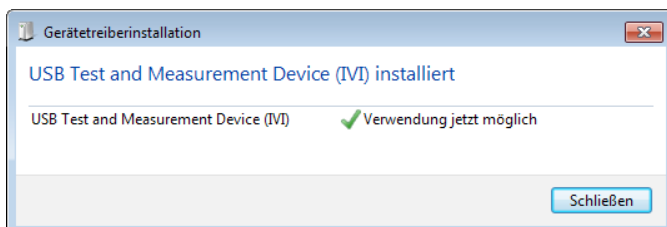

Fig. 14.7: Instrument driver installation

Once you open the Windows Device Manager, the following entry will be displayed: “USB Test and Measurement Devices --> USB Test and Measurement Device (IVI)”.

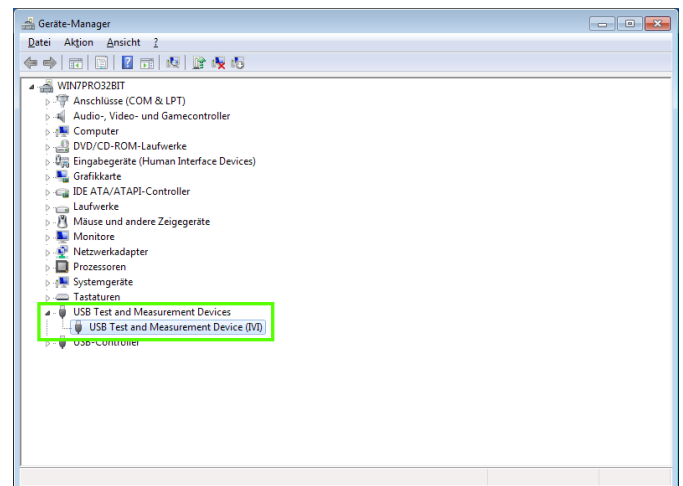

Fig. 14.8: Device manager

### 14.3 USB MTP

USB-MTP provides an easy solution to load data from the oscilloscope to the PC. This usually does not require a driver (according to Microsoft, USB MTP is automatically supported for Windows XP SP3 and higher). USB-MTP is unrelated to SCPI or the remote control of the instrument. It is merely applied to transfer data in file format. If you select the USB MTP function on the oscilloscope and if the instrument is connected to a PC, the instrument will display in the PC Device Manager as portable instrument.

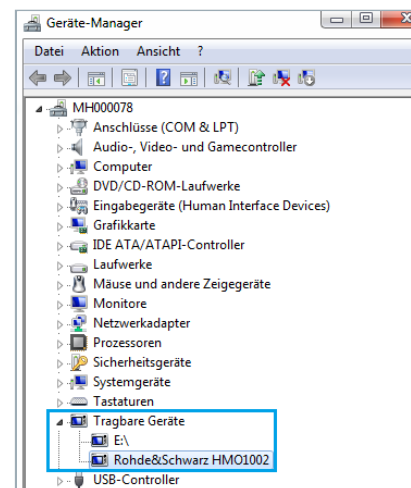

Fig. 14.9: Device manager display

The instrument includes three drives:

#### ■ Internal Storage:

Access to the files stored on the instrument, e.g. instrument settings, references, masks and formula sets (only for the R&S®HMO1202 series)

#### ■ Live Data:

Access to multiple subfolders, README.TXT file, SCREENSHOT and SETTINGS

#### ■ Upload:

Sending files to the oscilloscope (temporary drive)

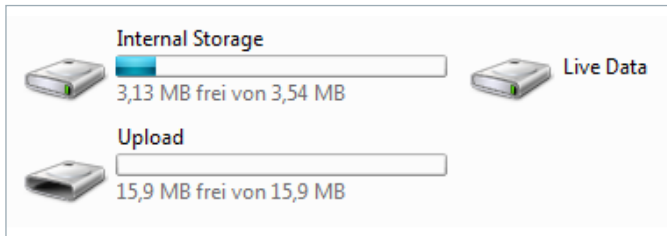

Fig. 14.10: Folder display

If a USB stick is connected to the oscilloscope, you can view the USB stick content via USB-MTP, or you can copy files to the PC. The USB stick displays as USB FRONT in the folder list. Contrary to the image preview in LIVE DATA which is only available via right click and the OPEN option, the image preview in USB FRONT is operational because the size indicated in Explorer corresponds to the actual file size. The file size in Explorer is overestimated at times to prevent Windows from simply truncating files while the PC is receiving them.

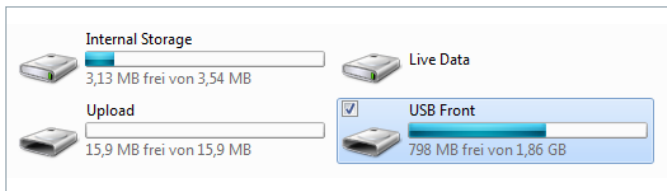

Fig. 14.11: Folder display with USB stick

**Sending files to the oscilloscope is only supported via UPLOAD drive. All other drives are read-only. There is no way to remove the write protection.**

### 14.3.1 Live Data

The LIVE DATA folder contains several subfolders and files. Each time a screenshot is opened, a current snapshot will be taken and sent to the PC. Double-clicking the snapshot will open the image preview which, however, fails to function in combination with the R&S®HMO1002 or R&S®HMO1202 series. Due to file compression, the size of the actual file sent is less than indicated in Explorer. This causes the image preview to issue an error. Therefore, screenshots can only be opened via right click and the OPEN option. The Settings file supplies the current instrument settings in the respective format.

The folders CHANNEL, BUS and POD contain two subfolders and a README.TXT. The subfolders contain files for the curve data in various formats. The files in the Acquisition Memory folder provide data from the acquisition memory, whereas the files in the DISPLAY DATA folder only provide visible curve data. The folders MATH and REFERENCES only contain visible curve data and therefore no subfolders are available. The respective INFO.TXT files contain significant information relating to the curves, such as name, units, samples etc. The file content is generated while the file is being sent to the PC. It is therefore recommended to only read curve data when the acquisition has been suspended (STOP mode). Reading the acquisition

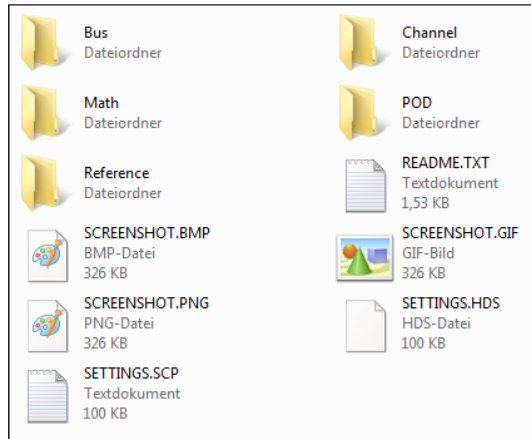

Fig. 14.12: Folder structure of LIVE DATA

memory is only useful when the acquisition has been suspended, otherwise, only the screen data will be read. To continue acquisition while reading the data may result in curve data from different acquisitions.

### 14.3.2 Upload

The UPLOAD folder is a temporary drive in the RAM of the oscilloscope. The content of this folder is purged when the instrument is turned off or restarted. This folder is intended to send specific files to the oscilloscope. If the PC copies a file into this folder, the oscilloscope will verify if this file can be loaded directly. The file transfer of .HDS and .SCP for instrument settings, .HLK for license keys and .HFU for firmware updates are supported. Other file transfers will be ignored. Instrument settings and license keys will be loaded without the PC requiring additional information. A firmware update must be started directly on the oscilloscope via soft menu key EXECUTE.

## 14.4 Ethernet

For the direct connection with a host (PC) or indirect connection over a SWITCH, a doubly protected network cable (e.g. CAT.5, CAT.5e, CAT.5+, CAT.6 or CAT.7) is required, equipped with an Ethernet plug type the RJ-45 at each end. Either an uncrossed or a crossed network cable (cross over cable) can be used.

### 14.4.1 IP networks (IP – Internet protocol)

In order that two or several network elements (e.g. measuring instruments, host/PC's, ...) can communicate over a network with one another, some fundamental connections have to be considered, so that data communication is error free and unimpaired. For each element in a network an IP address has to be assigned, so that they can exchange data among themselves. IP addresses are represented (with the IP version 4) as four decimal numbers separated by points (e.g. 192.168.15.1). Each decimal number is represented by a binary number of 8 bits. IP addresses are divided into public and private address ranges. Public IP addresses will be able to route by the Internet and an Internet service Provider (ISP) can be made available. Public IP addresses can be reached directly over the Internet to directly exchange internet data. Private IP addresses are not routed by the Internet and are reserved for private net-

works. Network elements with private IP addresses cannot be reached directly over the Internet so no data can be directly exchanged over the Internet. To allow network elements with a private IP address to exchange data over the Internet, they require a router for IP address conversion (English NAT; Network address translation), before connection to the Internet. The attached elements can then data exchange over this router, which possesses a private IP address (LAN IP address) and also a public IP address (WAN IP address), via the Internet.

If network elements exchange data only over a local network (without connection with the Internet), appropriate use private IP addresses. Select in addition e.g. a private IP address for the instrument and a private IP address for the host (PC), with which you would like to control the instrument. If you might connect your private network with the Internet later via a router, the private IP addresses used in your local network can be maintained. Since within each IP address range the first IP address is used as network IP address and the last IP address is used as Broadcast IP address, in each case two IP addresses have to be taken off from the "number of possible host addresses" (see table 1: Private IP address ranges). Apart from the organization of IP addresses into public and private address ranges, IP addresses are also divided into classes (Class: A, B, C, D, E). Within the classes A, B, and C are also include the private IP of address ranges described before. The categorisation from IP addresses is for the assignment of public IP address ranges of importance and essentially depends on the size of a local network (maximum number of hosts in the network), which is to be connected with the Internet (see table 2: Classes of IP addresses). IP addresses can fix (statically) or variable (dynamically) to be assigned. If IP addresses in a network are assigned fix, an IP address must be preset manually with each network element. If IP addresses in a network are assigned to the attached network elements automatically (dynamically), a DHCP server (English DHCP becomes; Dynamic Host Configuration Protocol) is required for the dispatching of IP addresses. With a DHCP server an IP address range for the automatic dispatching of IP addresses can be preset. A DHCP server is usually already integrated in a router (DSL router, ISDN

router, Modem router, WLAN router, ...) integrated. If a network element (e.g. an instrument) is connected by a network cable directly with a host (PC), the IP addresses cannot be assigned to the instrument and the host (PC) automatically, since no network with DHCP server is present here. They have to be preset therefore at the instrument and at the host (PC) manually.

IP addresses are divided by using subnet mask into a network quota and into a host quota, so similarly e.g. a telephone number is divided in pre selection (land and local area network number) and call number (user number). Subnet mask have the same form as IP addresses. They are represented with four decimal numbers separated by points (e.g. 255.255.255.0). As is the case for the IP addresses here each decimal number represents a binary number of 8 bits. The separation between network quota and host quota is determined by the subnet mask within an IP address (e.g. the IP address 192.168.10.10 by the subnet mask 255.255.255.0 is divided into a network quota 192.168.10.0 and a host quota of 0.0.0.10). The allocation takes place via the transformation of the IP address and the subnet mask in binary form and afterwards a bit by bit one logical AND operation between IP address and subnet mask. The result is the network quota of the IP address. The host quota of the IP address takes place via the bit by bit logical NAND operation between IP address and subnet mask. By the variable allocation of IP addresses in network quota and host quota via subnet masks, one can specify IP address ranges individually for large and small networks. Thus one can operate large and small IP networks and connect if necessary to the Internet via a router. In smaller local networks the subnet mask 255.255.255.0 is mostly used. Network quota (the first 3 numbers) and host quota (the last number) are simple here without much mathematical expenditure to determine and it can with these subnet mask up to 254 network elements (e.g. measuring instruments, hosts/PC's...) in a network be operated at the same time.

Often also a standard gateway is present in a network. In most local networks is this gateway with the router to the Internet (DSL router, ISDN router etc.) is identical. Using

address range	subnetz mask	CIDR way of writing	number of possible host addresses
10.0.0.0 –10.255.255.255	255.0.0.0	10.0.0.0/8	$2^{24} - 2 = 16.777.214$
172.16.0.0 –172.31.255.255	255.240.0.0	172.16.0.0/12	$2^{20} - 2 = 1.048.574$
192.168.0.0 –192.168.255.255	255.255.0.0 255.255.255.0	192.168.0.0/16 192.168.0.0/24	$2^{16} - 2 = 65.534$ $2^8 - 2 = 254$

Table 14.1: Private IP address ranges

class	address range	net quota	host quota	max. number of networks	max. number of hosts
A	0.0.0.1 - 127.255.255.255	8 Bit	24 Bit	126	16.777.214
B	128.0.0.1 - 191.255.255.255	16 Bit	16 Bit	16.384	65.534
C	192.0.0.1 - 223.255.255.255	24 Bit	8 Bit	2.097.151	254
D	224.0.0.1 - 239.255.255.255			Reserved for multicast applications	
E	240.0.0.1 - 255.255.255.255			Reserved for special applications	

Table 14.2: Classes of IP addresses

this (gateway -) router a connection can be manufactured with another network. Thus also network elements, which are not in the same (local) network, can be reached and/or network elements from the local network are able to exchange data with network elements from other networks. For a network-spreading data exchange the IP address of the standard gateway must also be preset. In local networks, mostly the first IP address within a network for this (gateway -) router is used. Mostly routers in a local network to be used as gateway have an IP address with a „1“ in the last place of the IP address (e.g. 192.168.10.1).

### 14.4.2 Ethernet Settings

**PC and instrument have to be connected to the same network. Otherwise a remote connection is not possible.**

In addition to the USB interface, the interface card includes an Ethernet interface. Configure the settings in the oscilloscope for all necessary parameters after you select ETHERNET as interface and press the soft menu key PARAMETER. You can specify all parameters and assign a fixed IP address. You can also assign a dynamic IP address with the activated DHCP function. Please contact your IT management to configure the settings properly.

**If DHCP is used and the system cannot assign an IP address to the oscilloscope (for instance, if no Ethernet cable is connected or the network does not support DHCP), it may take up to three minutes until a timeout allows the interface to be configured again.**

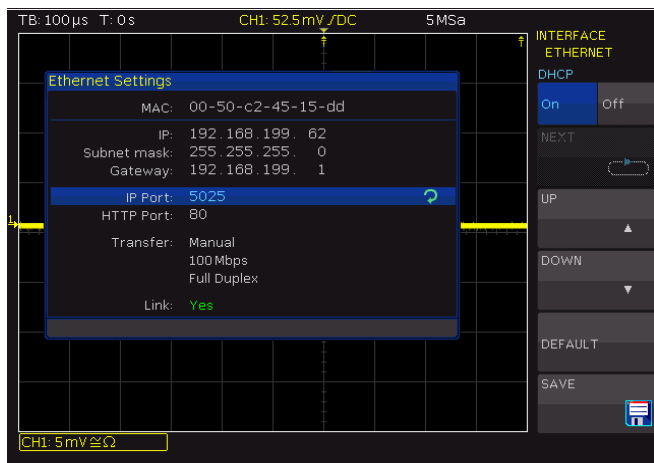

Fig. 14.9: Ethernet-settings dialog box

If the device has an IP address, it can be accessed via web browser at this IP since the Ethernet interface includes an integrated web server. Enter the IP address in the location bar on your browser (http://xxx.xxx.xxx.xx). This opens a window that includes the device name and type, serial number and interfaces with technical information and configured parameters.

# 15 Technical Data

## R&S®HMO1002 Series R&S®HMO1202 Series

### 2-channel digital oscilloscopes with 50/70/100/200/300MHz bandwidth

from firmware version 5.457

#### Display

Screen size / type	16,5cm (6,5") VGA color display
Resolution	640 (H) x 480 (V) pixels
Backlight	400cd/m <sup>2</sup> (LED)
Display range in horizontal direction	
without menu bar	12 Div (600 pixels)
with menu bar	10 Div (500 pixels)
Display range in vertical direction	
with VirtualScreen usage	8 Div (400 pixels)
Color depth	256 colors
Trace display	pseudo-color, inverse brightness
Levels of trace brightness	32

#### Vertical System

DSO mode	CH1, CH2
MSO mode (POD with logic probe R&S®HO3508)	
R&S®HMO1002 series	CH1, POD, Ext.In oder CH1, CH2, Ext.In
R&S®HMO1202 series	CH1, CH2, POD, Ext.In

#### Analog Channels

Y-bandwidth (-3dB)

(1 mV, 2mV)/Div

R&S®HMO1002 series	50 MHz
R&S®HMO1202 series	100 MHz

(5mV bis 10V)/Div

R&S®HMO1002	50 MHz
R&S®HMO1072	70 MHz
R&S®HMO1102	100 MHz
R&S®HMO1212	100 MHz
R&S®HMO1222	200 MHz
R&S®HMO1232	300 MHz

Lower AC bandwidth

Bandwidth limitation (switchable)

Rise time (calculated, 10% to 90%)

R&S®HMO1002 (50 MHz)	<7 ns
R&S®HMO1072 (70 MHz)	<5 ns
R&S®HMO1102 (100 MHz)	<3.5 ns
R&S®HMO1212 (100 MHz)	<3.5 ns
R&S®HMO1222 (200 MHz)	<1.75 ns
R&S®HMO1232 (300 MHz)	<1.15 ns

DC gain accuracy (all ranges)

Input sensitivity range	
all analog channels	1 mV/Div to 10V/Div
coarse stepping	13 calibrated steps, 1-2-5 sequence
variable stepping	freely between calibrated steps

Impedance

R&S®HMO1002 series	1 MΩ    16 pF ±2 pF
R&S®HMO1202 series	1 MΩ    16 pF ±2 pF, 50 Ω (switchable)

Coupling

Max. input voltage	
1 MΩ	200V <sub>p</sub> (derates at 20 db/decade to 5V above 100kHz)
50 Ω (R&S®HMO1202 series)	5V <sub>eff</sub> , max. 30V <sub>s</sub>
Position range	
R&S®HMO1002 series	±5 Div (from center of screen)
R&S®HMO1202 series	±15 Div (from center of screen)
Channel isolation	35dB from DC to specified bandwidth (same V/Div range)
XY mode	CH1, CH2
Inversion	selectively all analog channels

#### Logic Channels with Logic Probe R&S®HO3508

Thresholds	TTL, CMOS, ECL, user-defined (-2V to +8V)
Impedance	100kΩ    4pF
Coupling	DC
Max. input voltage	40V <sub>p</sub>

#### Trigger System

##### Trigger Mode

Auto	triggers automatically also without any specific trigger event
Normal	triggers only on specific trigger events
Single	triggers once on a trigger event
Trigger indicator	screen and panel (LED)

Trigger sensitivity

up to 5mV/Div	1.5 Div
from 5mV/Div	0.8 Div

Trigger level setting

with auto level	adjustable between peak values of a signal
without auto level	±5 Div (from center of screen)
external	-5V to +5V

#### Trigger Coupling

AC

R&S®HMO1002 series	<5mV/Div: 10 Hz to 65 MHz >5mV/Div: 10 Hz to 65/90/130 MHz
--------------------	---

R&S®HMO1202 series	<5mV/Div: 10 Hz to 130 MHz >5mV/Div: 10 Hz to 130/220/300 MHz
--------------------	--

DC

R&S®HMO1002 series	<5mV/Div: DC to 65 MHz >5mV/Div: DC to 65/90/130 MHz
--------------------	---

R&S®HMO1202 series	<5mV/Div: DC to 130 MHz >5mV/Div: DC to 130/220/300 MHz
--------------------	--

HF

R&S®HMO1002 series	<5mV/Div: 30 kHz to 65 MHz >5mV/Div: 30 kHz to 65/90/130 MHz
--------------------	---

R&S®HMO1202 series	<5mV/Div: 30 kHz to 130 MHz >5mV/Div: 30 kHz to 130/220/300 MHz
--------------------	--

selectable filters

LF	DC to 5kHz (-3db), selectable in DC and auto level mode
----	---

noise rejection	min. level: 1.5 Div (> 5mV/Div) selectable with AC, DC and HF coupling
-----------------	---

Trigger hold-off

auto, 50 ns to 10 s

#### External Input (BNC)

Function	ext. trigger input, additional digital channel
Impedance	1 MΩ    16 pF ±2 pF
Accuracy	300mV <sub>SS</sub>
Trigger level range	-5V bis +5V

## Technical Data

Max. input voltage	100 V <sub>s</sub> (derates at 20 db/decade to 5V above 100 kHz)
<b>Trigger coupling</b>	
AC	
R&S®HMO1002 series R&S®HMO1202 series	10 Hz to 50/70/100 MHz 10 Hz to 100/200/300 MHz
DC	
R&S®HMO1002 series R&S®HMO1202 series	DC to 50/70/100 MHz DC to 100/200/300 MHz
<b>Trigger Output via AUX OUT (BNC)</b>	
Functions	Pulse output for every acquisition trigger event, error output on mask violation
Output level	approx. 3V
Pulse polarity	positive
Pulse width	>150 ns (trigger event), >0.5 μs (mask violation)
<b>Trigger Types</b>	
<b>Edge</b>	
Direction	rising, falling, both
Trigger coupling	auto level AC, DC, HF
Switchable filters	LF, noise rejection
<b>Sources</b>	
R&S®HMO1002, R&S®HMO1202	all analog and digital channels, AC line, external (AC, DC)
<b>Pulse Width</b>	
Polarity	positive, negative
Functions	equal, not equal, lower, higher, within/without a range
Pulse duration	16 ns to 10 s, resolution min. 2 ns
Sources	all analog channels
<b>Logic</b>	
Functions	
boolean operators	AND, OR, TRUE, FALSE
time based operators	equal, not equal, lower, higher, within/without a time range, timeout
Duration	16 ns to 10 s, resolution min. 2 ns
States	H, L, X
Sources	all logic channels
<b>Video</b>	
Sync. pulse polarity	positive, negative
Supported standards	NTSC, SECAM, PAL, PAL-M, SDTV 576i, HDTV 720p, HDTV 1080i, HDTV 1080p
Field	even/odd, either
Line	line number selectable, all
Sources	all analog channels, external (AC, DC)
<b>Serial Busses (optional)</b>	
Bus representation	Up to two busses can be analyzed at the same time. Color-coded display of decoded data in ASCII, binary, decimal and hexadecimal format.
Option / Voucher codes	
R&S®HOO10, R&S®HV110	Analysis of I <sup>2</sup> C, SPI, UART/RS-232 signals on analog and logic channels
R&S®HOO11, R&S®HV111	Analysis of I <sup>2</sup> C, SPI, UART/RS-232 signals on all analog channels
R&S®HOO12, R&S®HV112	Analysis of CAN and LIN signals on analog and logic channels

<b>Trigger types by protocols</b>	
I <sup>2</sup> C	Start, Stop, ACK, NACK, Address/Data
SPI	Start, End, Serial Pattern (32 Bit)
UART/RS-232	Startbit, Frame Start, Symbol, Pattern
LIN	Frame Start, Wake Up, Identifier, Data, Error
CAN	Frame Start, Frame End, Identifier, Data, Error
<b>Horizontal System</b>	
Time domain (Yt)	main screen, time domain and zoom window
Frequency domain (FFT)	time domain and frequency domain window (FFT)
XY mode	voltage (XY)
VirtualScreen	virtual display of ±10 Div for all math, logic, bus, reference signals
Component tester	voltage (X), current (Y)
Reference signals	up to 4 references
Channel deskew	±32 ns, step size 2 ns
Memory zoom	up to 50.000:1
Time base	
accuracy	±50.0 × 10 <sup>-6</sup>
aging	±10.0 × 10 <sup>-6</sup> per year
Operation modes	
REFRESH	
R&S®HMO1002 series R&S®HMO1202 series	2 ns/Div to 50 s/Div 1 ns/Div to 50 s/Div
ROLL	50 ms/Div to 50 s/Div
<b>Acquisition System</b>	
<b>Realtime Sampling Rate</b>	
Analog channels	
R&S®HMO1002 series R&S®HMO1202 series	2x 500 MSa/s or 1x 1 GSa/s 2x 1 GSa/s or 1x 2 GSa/s
Logic channels	
R&S®HMO1002 series R&S®HMO1202 series	8x 500 MSa/s 8x 1 GSa/s
<b>Memory depth</b>	
Analog channels	
R&S®HMO1002 series R&S®HMO1202 series	2x 500 kSa or 1x 1 MSa 2x 1 MSa or 1x 2 MSa
Logic channels	
R&S®HMO1002 series R&S®HMO1202 series	500 kSa per channel 1 MSa per channel
Resolution	8 Bit, (HiRes up to 16Bit)
Waveform arithmetics	refresh, roll (loose/triggered), average (up to 1024), envelope, peak detect (2 ns), filter (low- pass, adjustable), high resolution (up to 16 bit)
Record modes	automatic, max. sampling rate, max. waveform rate
<b>Interpolation</b>	
all analog channels	sin(x)/x, linear, sample-hold
logic channels	pulse
<b>Delay</b>	
pre-trigger	
R&S®HMO1002 series R&S®HMO1202 series	0 to 500.000 Sa × (1/sample rate) 0 to 1.000.000 Sa × (1/sample rate) (multiplied by 2 in interlaced mode)
post-trigger	0 to 8x10 <sup>6</sup> Sa × (1/sample rate)
Waveform update rate	up to 10,000 Wfm/s



Waveform display	dots, vectors, persistence afterglow
Persistence afterglow	min. 50ms
<b>Waveform Measurements and Operation</b>	
Operation	menu-driven (multilingual), auto-set, help functions (multilingual)
Automatic measurements	voltage ( $V_{pp}$ , $V_{p+}$ , $V_{p-}$ , $V_{rms}$ , $V_{avg}$ , $V_{min}$ , $V_{max}$ ), amplitude, phase, frequency, period, rise/fall time (80%, 90%), pulse width (pos/neg), burst width, duty cycle (pos/neg), standard deviation, delay, crest factor, overshoot (pos/neg), edge/pulse count (pos/neg), trigger period, trigger frequency
Cursor measurements	voltage ( $V1$ , $V2$ , $\Delta V$ ), time ( $t1$ , $t2$ , $\Delta t$ , $1/\Delta t$ ), ratio X, ratio Y, pulse and edge count (pos/neg), peak values ( $V_{pp}$ , $V_{p+}$ , $V_{p-}$ ), $V_{mean}$ , $V_{rms}$ , standard deviation, duty cycle (pos/neg), rise/fall time (80%, 90%), ratio marker, crest factor
Quick measurements (QUICKVIEW)	voltage ( $V_{pp}$ , $V_{p+}$ , $V_{p-}$ , $V_{rms}$ , $V_{mean}$ ), rise/fall time, frequency, period plus 6 additional measurement functions (see automatic measurement functions, freely selectable)
Marker	up to 8 freely positionable markers for easy navigation
<b>Frequency Counter (hardware based)</b>	
Resolution	5 digit
Frequency range	
R&S®HMO1002 R&S®HMO1202	0.5 Hz bis 50/70/100 MHz 0.5 Hz bis 100/200/300 MHz
Accuracy	$\pm 50.0 \times 10^{-6}$
Aging	$\pm 10.0 \times 10^{-6}$ per year
<b>Mask Testing</b>	
Functions	Pass/Fail comparison with an user-defined mask performed on waveforms
Sources	all analog channels
Mask definition	Mask enclosing acquired waveform with user-defined tolerance
Actions	
on mask violations	beep, acquisition stop, screenshot, trigger pulse, automatically saving trace data
during acquisition	statistics: number of completed tests, number of passes / failed acquisitions (absolute and in percent), test duration
<b>Waveform Maths</b>	
<b>Quickmath</b>	
Functions	addition, subtraction, multiplication, division
Sources	CH1, CH2
<b>Mathematics (R&amp;S®HMO1202 series)</b>	
Functions	addition, subtraction, multiplication, division, minimum / maximum, square, square root, absolute value, pos/neg wave, reciprocal, inverse, log10/ln, derivation, integration, filter (lowpass/highpass)
Editing	formula editor, menu-driven
Sources	all analog channels, user-defined constants
Storage location	math. memory
Number of formula sets	5 formula sets
Number of equations	5 equations per formula set
Simultaneous display of math. functions	1 formula set with max. 4 equations
<b>Frequency Analysis (FFT)</b>	
Parameters	frequency span, center frequency, vertical scale, vertical position

FFT length	2Kpts, 4Kpts, 8Kpts, 16Kpts, 32Kpts, 64Kpts, 128Kpts
Window	Hanning, Hamming, Rectangular, Blackman
Scale	dBm, dBV, $V_{rms}$
Waveform arithmetics	refresh, envelope, average (up to 512)
Cursor measurement	2 horizontal cursors, previous / next peak search
Sources	all analog channels
<b>Probe Adjust Output</b>	
Operation	manual, adjust-wizzard
Frequency	1 kHz, 1 MHz
Level	
R&S®HMO1002 series R&S®HMO1202 series	approx. $2.5V_{pp}$ ( $t_a < 4ns$ ) approx. $2.5V_{pp}$ ( $t_a < 1ns$ )
<b>Pattern Generator</b>	
Functions	square wave / probe adjust, bus signal source, counter, programmable pattern
Square wave (Probe ADJ output)	frequency range: $< 1$ MHz to 500 kHz level: $2.5V_{pp}$ ( $t_a < 4ns$ ) polarity: normal, invert duty cycle: 1% to 99%
Bus Signal Source (4 Bit)	I <sup>2</sup> C (100 kBit/s, 400 kBit/s, 1 MBit/s), SPI (100 kBit/s, 250 kBit/s, 1 MBit/s), UART (9600 Bit/s, 115,2 kBit/s, 1 MBit/s), CAN (up to 50 MBits/s), LIN (up to 50 MBits/s)
Counter (4 Bit)	frequency: $< 1$ MHz to 25 MHz direction: incrementing, decrementing
Programmable pattern (4 Bit)	sampling time: 20 ns to 42 s memory depth: 2048 sa pattern idle time: 20 ns to 42 s
<b>Function Generator</b>	
Waveform modes	DC, sine, square, triangle/ramp, pulse
Sine	frequency range: 0.1 Hz to 50 kHz flatness: $\pm 1$ dB relative to 1 kHz DC offset: max. $\pm 3V$
Square	frequency range: 0.1 Hz to 25 kHz rise time: $< 4\mu s$ DC offset: max. $\pm 3V$
Triangle / Ramp	frequency range: 0,1 Hz bis 10 kHz DC offset: max. $\pm 3V$
Pulse	frequency range: 0.1 Hz to 10 kHz duty cycle: 10% to 90% DC offset: max. $\pm 3V$
Sampling rate	978 kSa/s
Frequency accuracy	$\pm 50.0 \times 10^{-6}$
Aging	$\pm 10.0 \times 10^{-6}$ per year
Amplitude	
DC	$\pm 3V$
DC offset error (meas.)	$\pm 25mV$ (max.)
high impedance load	60 mV <sub>pp</sub> to 6 V <sub>pp</sub>
50 $\Omega$ load	30 mV <sub>pp</sub> to 3 V <sub>pp</sub>
accuracy	3%
<b>Digital Voltmeter</b>	
Display (3-digit)	Primary and secondary measurement value per channel, simultaneous measuring on all channels
Functions	DC, DC <sub>rms</sub> , AC <sub>rms</sub> , $V_{pp}$ , $V_{p+}$ , $V_{p-}$ , crest factor
Sources	all analog channels

## Technical Data

Component Tester	
Parameters	voltage (X), current (Y)
Testing frequency	50 Hz, 200 Hz
Voltage	10 V <sub>p</sub> (open)
Current	10 mA (short)
Reference potential	Ground (PE)
Interfaces	
for mass storage (FAT16/32)	1x USB host (type A), max. 500 mA
for remote control	Ethernet (RJ45), USB device (type B)
General Data	
Application memory	3 MB for references and device settings
Save / Recall	
device settings	on internal file system or external USB memory, available file formats: SCP, HDS
reference waveforms	on internal file system or external USB memory, available file formats: BIN (MSB/LSB), FLT (MSB/LSB), CSV, TXT, HRT
traces	on external USB memory, available file formats: BIN (MSB/LSB), FLT (MSB/LSB), CSV, TXT
data	display or acquisition data
sources	single or all analog channels
screenshots	on external USB memory, available file formats: BMP, GIF, PNG (color, inverted, grey-scale)
Realtime clock (RTC)	date and time
Power supply	
AC supply	100 V to 240 V, 50 Hz to 60 Hz, CAT-II
power consumption	
R&S®HMO1002 R&S®HMO1202	max. 25 W max. 30 W
Safety	in line with IEC 61010-1 (ed. 3), IEC 61010-2-30 (ed. 1), EN 61010-1, EN 61010-2-030, CAN/CSA-C22.2 No. 61010-1-12, CAN/CSA-C22.2 No. 61010-2-030-12, UL Std. No. 61010-1 (3rd Edition), UL61010-2-030
Temperature	
operating temp. range	+5 °C to +40 °C
storage temperature range	-20 °C to +70 °C
Rel. humidity	5% to 80% (without condensation)
Mechanical data	
dimensions (W x H x D)	285 x 175 x 140 mm
net weight	1.7 kg
EMC	
RF emission	in line with CISPR 11/EN 55011 class B
Immunity	in line with IEC/EN 61326-1 table 2, immunity test requirements for industrial environments. Test criterion is displayed noise level within ±1 div for 5 mV/div input sensitivity

All specifications at 23°C after 30 minutes warm-up

Measured value (meas.): characterizes an expected product performance by means of measurement results gained from individual samples.

## Bandwidth Upgrades R&S®HMO1002 Series

Description	Option Code	Voucher Code
Bandwidth upgrade 50 MHz to 70 MHz	R&S®HOO572	R&S®HV572
Bandwidth upgrade 50 MHz to 100 MHz	R&S®HOO512	R&S®HV512
Bandwidth upgrade 70 MHz to 100 MHz	R&S®HOO712	R&S®HV712

## Bandwidth Upgrades R&S®HMO1202 Series

Description	Option Code	Voucher Code
Bandwidth upgrade 100 MHz to 200 MHz	R&S®HOO312	R&S®HV312
Bandwidth upgrade 100 MHz to 300 MHz	R&S®HOO313	R&S®HV313
Bandwidth upgrade 200 MHz to 300 MHz	R&S®HOO323	R&S®HV323

## Bus Analysis Options

Description	Option Code	Voucher Code
I <sup>2</sup> C, SPI, UART/RS-232 on analog and digital channels	R&S®HOO10	R&S®HV110
I <sup>2</sup> C, SPI, UART/RS-232 on all analog channels	R&S®HOO11	R&S®HV111
CAN und LIN on analog and digital channels	R&S®HOO12	R&S®HV112

### Accessories included:

Line cord, printed operating manual, 2x HZ154 probes (R&S®HMO1002) or 2x RT-ZP03 probes (R&S®HMO1202), HZ20 adapter: BNC plug to 4 mm banana sockets, software-CD

### Accessories:

HO3508	8 channel logic probe (350 MHz, 4 pF)
HZ115	Differential Probe 100:1/1000:1
HZO20	High voltage probe 1000:1 (400 MHz, 1000 V <sub>rms</sub> )
HZO30	1 GHz active probe (0.9 pF, 1 MΩ)
HZO40	Active differential probe 200 MHz (10:1, 3.5 pF, 1 MΩ)
HZO41	Active differential probe 800 MHz (10:1, 1 pF, 200 kΩ)
HZO50	AC/DC Current Probe 30 A, DC to 100 kHz
HZO51	AC/DC Current Probe 100/1000 A, DC to 20 kHz
HZ51	150 MHz passive probe 10:1 (12 pF, 10 MΩ)
HZ52	250 MHz passive probe 10:1 (10 pF, 10 MΩ)
HZ53	100 MHz passive probe 100:1 (4.5 pF, 100 MΩ)
HZO90	Carrying case for protection and transport
HZO91	4RU 19" rackmount kit

# 16 Appendix

## 16.1 List of figures

Fig. 1.1:	Operating positions. . . . .	4	Fig. 9.12:	Digital Voltmeter. . . . .	38
Fig. 1.2:	Product labeling in accordance with EN 50419. . . . .	6	Fig. 10.1:	Arbitrary menu . . . . .	39
Fig. 2.1:	Frontview of the R&S®HMO1202. . . . .	8	Fig. 10.2:	Arbitrary pattern setup . . . . .	40
Fig. 2.2:	Control panel of section A . . . . .	8	Fig. 11.1:	Basic menu for instrument settings . . . . .	41
Fig. 2.3:	Control panels of sections B, C and D . . . . .	9	Fig. 11.2:	Storing instrument settings . . . . .	41
Fig. 2.4:	UPGRADE menu. . . . .	11	Fig. 11.3:	Storage menu for references . . . . .	42
Fig. 2.5:	Manual input of the license key . . . . .	11	Fig. 11.4:	Trace storage menu . . . . .	43
Fig. 2.6:	Self alignment successful. . . . .	11	Fig. 11.5:	Supported printer example . . . . .	43
Fig. 2.7:	Self alignment logic probe . . . . .	12	Fig. 11.6:	Screenshot module. . . . .	44
Fig. 2.8:	Back panel. . . . .	12	Fig. 11.7:	Definition of FILE/PRINT key . . . . .	44
Fig. 3.1:	Control panel of section A . . . . .	13	Fig. 12.1:	Optional logic probe R&S®HO3508 . . . . .	44
Fig. 3.2:	Screen display after connection of the probe . . . . .	13	Fig. 12.2:	8 Bit DAC signal change. . . . .	45
Fig. 3.3:	Screen display after changing to DC coupling. . . . .	13	Fig. 13.1:	Menu for the definition of buses . . . . .	47
Fig. 3.4:	Screen display after Autosetup. . . . .	13	Fig. 13.2:	Example I <sup>2</sup> C BUS with BUS table. . . . .	47
Fig. 3.5:	Section D of the control panel with zoom key. . . . .	13	Fig. 13.3:	Example PARALLEL BUS with BUS table . . . . .	48
Fig. 3.6:	ZOOM function. . . . .	14	Fig. 13.4:	I <sup>2</sup> C 7-Bit-Address. . . . .	48
Fig. 3.7:	Quick View parameter measurement. . . . .	14	Fig. 13.5:	I <sup>2</sup> C Read/Wrtie trigger menu . . . . .	49
Fig. 3.8:	Selection of parameters . . . . .	14	Fig. 13.6:	I <sup>2</sup> C BUS . . . . .	49
Fig. 3.9:	Save/Recall menu . . . . .	15	Fig. 13.7:	I <sup>2</sup> C BUS Table . . . . .	50
Fig. 3.10:	Screenshot menu . . . . .	15	Fig. 13.8:	Simple configuration of SPI BUS . . . . .	50
Fig. 4.1:	Control panel for the vertical system . . . . .	16	Fig. 13.9:	Menu for the definition of a SPI bus. . . . .	51
Fig. 4.1:	Short menu for vertical settings . . . . .	16	Fig. 13.10:	Example SSPI BUS table . . . . .	51
Fig. 4.2:	Probe compensation wizard. . . . .	17	Fig. 13.11:	UART bit sequence . . . . .	52
Fig. 4.3:	Name selection . . . . .	17	Fig. 13.12:	Trigger menu UART data . . . . .	52
Fig. 5.1:	Control panel of the horizontal system. . . . .	18	Fig. 13.13:	Page 2 2 UART BUS setup menu . . . . .	52
Fig. 5.2:	AM modulated signal with maximum repeat rate 19		Fig. 13.14:	UART trigger menu page 2. . . . .	53
Fig. 5.3:	Example figure of AM modulated signal with max. sampling rate. . . . .	20	Fig. 13.15:	Example UART BUS table. . . . .	53
Fig. 5.4:	Example figure of AM modulated signal with automatic setting . . . . .	20	Fig. 13.16:	CAN BUS configuration . . . . .	54
Fig. 5.5:	Zoom function. . . . .	21	Fig. 13.17:	CAN BUS. . . . .	54
Fig. 5.6:	Marker in Zoom mode . . . . .	22	Fig. 13.18:	Example CAN BUS table. . . . .	55
Fig. 6.1:	Control panel for the trigger system. . . . .	22	Fig. 13.19:	LIN byte structure . . . . .	55
Fig. 6.2:	Filter settings of edge trigger . . . . .	23	Fig. 13.20:	LIN BUS menu . . . . .	56
Fig. 6.3:	Logic trigger menu . . . . .	24	Fig. 13.21:	LIN data trigger menu. . . . .	56
Fig. 6.4:	Logic channels' settings display. . . . .	24	Fig. 13.22:	LIN BUS. . . . .	56
Fig. 6.5:	Video trigger menu . . . . .	25	Fig. 13.23:	Example LIN BUS table . . . . .	57
Fig. 6.6:	External trigger signal. . . . .	25	Fig. 14.1:	NI-VISA 5.4.1. . . . .	58
Fig. 7.1:	Drawing of the virtual screen area . . . . .	26	Fig. 14.2:	NI-VISA installation instructions . . . . .	58
Fig. 7.2:	Persistence function . . . . .	27	Fig. 14.3:	NI-VISA feature installation locally . . . . .	58
Fig. 8.1:	Cursor measurement setting menu . . . . .	29	Fig. 14.4:	Setup menu. . . . .	58
Fig. 8.2:	Auto measurement setting menu . . . . .	31	Fig. 14.5:	Interface menu . . . . .	59
Fig. 9.1:	Example of a mathematical waveform. . . . .	32	Fig. 14.6:	Interface parameter menu . . . . .	59
Fig. 9.2:	Quick Mathematics menu . . . . .	32	Fig. 14.7:	Instrument driver installation . . . . .	59
Fig. 9.3:	Formula editor for formula sets . . . . .	33	Fig. 14.8:	Device manager . . . . .	59
Fig. 9.4:	Entry of constants and units. . . . .	33	Fig. 14.9:	Device manager display . . . . .	59
Fig. 9.5:	Definition of the current equation . . . . .	34	Fig. 14.9:	Ethernet-settings dialog box. . . . .	62
Fig. 9.6:	Definition of the power equation . . . . .	34	Fig. 14.10:	Folder display . . . . .	60
Fig. 9.7:	FFT. . . . .	35	Fig. 14.11:	Folder display with USB stick. . . . .	60
Fig. 9.8:	PASS/FAIL mask test. . . . .	36	Fig. 14.12:	Folder structure of LIVE DATA . . . . .	60
Fig. 9.9:	HZ20 adapter connected to AUX OUT. . . . .	37			
Fig. 9.10:	Component test example. . . . .	37			
Fig. 9.11:	Excamples of Component test . . . . .	38			

## 16.2 Glossary

A

AC coupling: 16

attenuation: 16

AVERAGE: 18, 35

B

Blackman window function: 35

## Appendix

brightness: 25, 26, 27  
bus analysis: 10, 17, 46  
BUS configuration: 46, 47, 48, 49, 50, 51, 52, 54, 55, 56  
BUS signal: 9, 40  
BUS Signal Source: 40  
BUS type: 45, 46, 47, 50

### C

CAN bus: 53  
component tester: 5, 37, 38  
component test mode: 9  
crest factor: 28, 29  
CVBS signal: 25

### D

DC coupling: 13, 16, 23  
digital voltmeter: 38  
duty cycle: 14, 39

### E

edge trigger: 23  
Education Mode: 12  
ENVELOPE: 18, 35  
Ethernet: 10, 12, 57, 61

### F

Fall time: 35  
frequency interferences: 18  
function generator: 5, 39

### G

Grayscale mode: 10

### H

Hamming/Hanning window function: 35  
Hold off time: 22

### I

I<sup>2</sup>C bus: 48  
interlace mode: 21

### L

licence key: 11, 46  
LIN bus: 55  
Lissajous: 27  
logic channels: 44, 45, 46, 48  
logic mode: 24  
logic probe: 8, 9, 11, 22, 24, 44, 46  
Logic Trigger: 24, 44  
low pass filter: 16, 18, 23, 33

### M

mask test: 8, 36  
mathematical graph: 15  
maximum repeat rate: 19, 20  
measurement categories: 5  
measurement source: 30  
memory depth: 19, 20, 21  
mixed-signal operation: 11

### P

Pass/Fail test: 8, 36  
pattern depth: 39  
pattern generator: 39, 40  
peak detection: 19, 20  
peak voltage: 14, 16, 36  
Persistence mode: 27  
polarity: 25, 37, 39, 54  
probe attenuation detection: 16  
probe compensation: 13, 17, 39  
pulse trigger: 23, 24  
pulse width: 14, 23, 24, 30, 36

### Q

Quick Mathematics: 32  
Quick view: 8, 14, 36

### R

rectangle function: 35  
resistance: 5  
resistance measurement: 5  
RMS: 14, 28, 29, 36, 38

### S

sampling frequency: 18  
sampling rate: 9, 18, 19, 20, 21, 42, 46  
screen displays: 8, 15, 38, 41  
screenshot: 12, 15, 43, 44  
Self Alignment: 11  
semiconductors: 37  
signal amplitude: 29, 30, 39  
signal source: 16  
signal voltage: 25  
SPI bus: 50, 51  
square wave signal: 13, 29  
standard deviation: 28, 30

### T

threshold: 17, 24, 28, 46, 48, 50, 52, 54, 55  
trigger conditions: 9, 18, 22, 23, 25, 49, 51, 53, 54, 56  
trigger event: 17, 22, 25, 26, 51, 53  
trigger level: 9, 17, 23, 24  
trigger modes: 22  
trigger signal: 9, 22, 23, 31  
trigger slope: 9  
trigger source: 21, 22, 24, 31  
trigger time: 18, 21, 24, 46, 51  
trigger type: 9, 22, 23, 24, 26, 52

### U

UART bus: 52  
UART trigger settings: 53  
USB interface: 12, 61  
USB port: 8, 10, 11  
USB TMC class: 57, 58

### V

video modulation: 25  
V marker: 14, 28, 46







이 기기는 업무용(A급) 전자파  
적합기기로서 판매자 또는  
사용자는 이 점을 주의하시기  
바라며, 가정외의 지역에서  
사용하는 것을 목적으로 합니다.

© 2016 Rohde & Schwarz GmbH & Co. KG

Mühlhofstr. 15, 81671 München, Germany

Phone: +49 89 41 29 - 0

Fax: +49 89 41 29 12 164

E-mail: [info@rohde-schwarz.com](mailto:info@rohde-schwarz.com)

Internet: [www.rohde-schwarz.com](http://www.rohde-schwarz.com)

Customer Support: [www.customersupport.rohde-schwarz.com](http://www.customersupport.rohde-schwarz.com)

Service: [www.service.rohde-schwarz.com](http://www.service.rohde-schwarz.com)

Subject to change – Data without tolerance limits is not binding.

R&S® is a registered trademark of Rohde & Schwarz GmbH & Co. KG.

Trade names are trademarks of the owners.

5800.5301.02 | Version 03 | R&S®HMO1x02 Serie

The following abbreviations are used throughout this manual: R&S®HMO1x02 Serie is abbreviated as R&S HMO1x02 Serie.